



MPQ3414B

1.5A, 2.2MHz, 5V_{OUT}, 52μA I_Q, Synchronous Step-Up Converter with Output Disconnect, AEC-Q100 Qualified

DESCRIPTION

The MPQ3414B is a high-efficiency, synchronous, current-mode step-up converter with output disconnect.

The MPQ3414B can start up from an input voltage (V_{IN}) as low as 1.8V, while also providing inrush current limiting and output short-circuit protection (SCP). The integrated P-channel synchronous rectifier improves efficiency and eliminates the need for an external Schottky diode. If the MPQ3414B shuts down, then the P-channel MOSFET disconnects the output from the input. Output disconnect discharges the output completely, which allows the MPQ3414B to draw a supply current (I_{SD}) below 1μA during shutdown.

The 2.2MHz fixed switching frequency (f_{sw}) allows for the use of small external components. Internal compensation and soft start (SS) reduce the number of external components required. These features provide a compact solution for a wide current load range.

The MPQ3414B features an integrated power MOSFET that supports up to 5V of output voltage (V_{OUT}), and up to 0.5A of average output current (I_{OUT}), with up to 1A of peak I_{OUT} (I_{OUT_PEAK}).

The MPQ3414B requires a minimal number of standard, external components, and is available in a compact TSOT23-8 package.

FEATURES

- 2.8V to 4V Input Voltage (V_{IN}) Range
- Up to 5V Output Voltage (V_{OUT})
- Up to 0.5A Output Current (I_{OUT})
- Internal Synchronous Rectifier
- 2.2MHz Fixed Switching Frequency (f_{sw})
- 52μA Quiescent Current (I_Q)
- <1μA Shutdown Current (I_{SD})
- Output Disconnect
- Up to 85% Efficiency
- Internal Compensation, Inrush Current Limiting, and Internal Soft Start (SS)
- Small External Components
- Over-Voltage Protection (OVP), Short-Circuit Protection (SCP), and Over-Temperature Protection (OTP)
- Available in a TSOT23-8 Package
- Available in AEC-Q100 Grade 1

APPLICATIONS

- Single-Cell Li-Ion Backup Batteries
- Automotive Secondary Regulation

All MPS parts are lead-free, halogen-free, and adhere to the RoHS directive. For MPS green status, please visit the MPS website under Quality Assurance. "MPS", the MPS logo, and "Simple, Easy Solutions" are trademarks of Monolithic Power Systems, Inc. or its subsidiaries.

TYPICAL APPLICATION

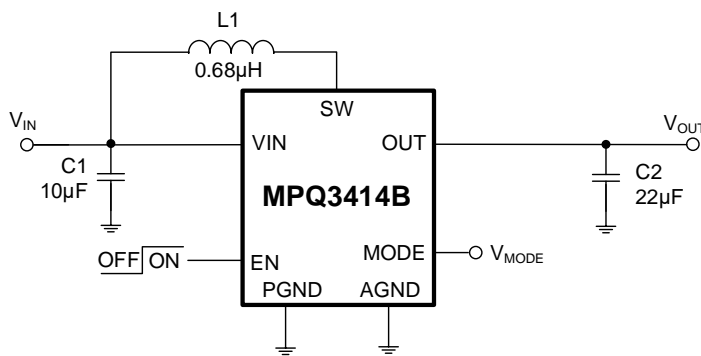

Efficiency vs. Load Current
AAM mode

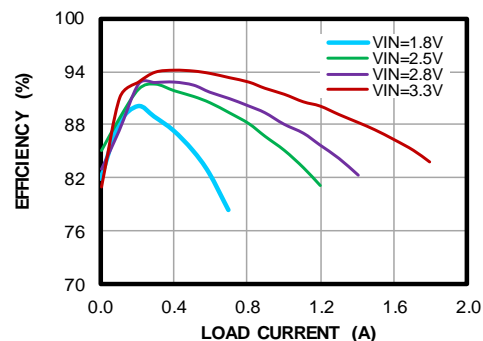

ORDERING INFORMATION

Part Number*	Package	Top Marking	MSL Rating
MPQ3414BGJ-5-AEC1	TSOT23-8	See Below	1

* For Tape & Reel, add suffix -Z (e.g. MPQ3414BGJ-5-AEC1-Z).

TOP MARKING

| BGLY

BGL: Product code

Y: Year code

PACKAGE REFERENCE

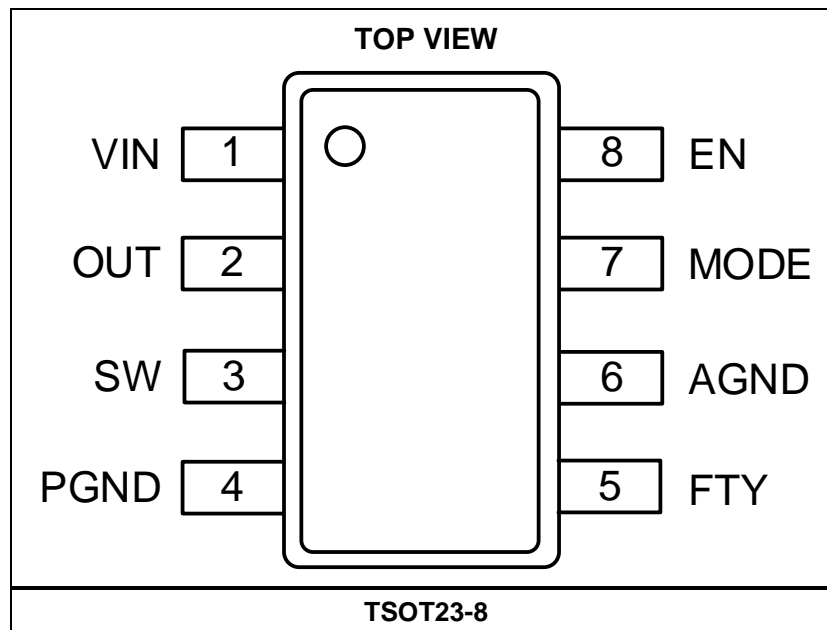

PIN FUNCTIONS

Pin #	Name	Pin Function
1	VIN	Power supply input. The start-up bias is derived from the VIN pin, which should be bypassed locally. Once the output voltage (V _{OUT}) exceeds the input voltage (V _{IN}), the bias is derived from the OUT pin.
2	OUT	Synchronous rectifier output. The OUT pin is the drain of the internal synchronous rectifier. If V _{OUT} exceeds V _{IN} , then the bias is derived from the VIN pin. Connect OUT to the output capacitors using short and wide traces. Output disconnect allows the output to be discharged from the input completely while the EN pin is pulled low. OUT is also the sense point for voltage regulation.
3	SW	Power switch output. The SW pin is the connection node of the internal low-side MOSFET (LS-FET) and the synchronous MOSFET. Connect the inductor between the SW and VIN pins. Keep the SW trace as short and wide as possible to reduce EMI and voltage spikes.
4	PGND	Power ground.
5	FTY	Factory use only. Float the FTY pin or connect FTY to ground (AGND or PGND).
6	AGND	Analog ground.
7	MODE	Mode selection. Pull the MODE pin high to enter advanced asynchronous modulation (AAM). Pull MODE low to enter forced continuous conduction mode (FCCM). Do not adjust the MODE pin during operation.
8	EN	Enable control. Pull the EN pin above 1.2V to turn on the converter; pull EN below 0.4V to turn it off.

ABSOLUTE MAXIMUM RATINGS ⁽¹⁾

V _{SW} , V _{OUT}	-0.3V to +6.5V
V _{SW} (<5ns)	-0.3V to +9V
All other pins	-0.3V to +6.5V
Continuous power dissipation (T _A = 25°C) ⁽²⁾	1.25W
Junction temperature	150°C
Lead temperature	260°C
Storage temperature	-65°C to +150°C

ESD Ratings

Human body model (HBM)	±2kV
Charged device model (CDM).....	±750V

Recommended Operating Conditions ⁽³⁾

Input voltage (V _{IN})	2.8V to 4V ⁽⁴⁾
Enable (EN) voltage (V _{EN}).....	0V to 4V
Operating junction temp (T _J)....	-40°C to +125°C

Thermal Resistance ⁽⁵⁾ θ_{JA} θ_{JC}

TSOT23-8	100	55	°C/W
----------------	-----	----	------

Notes:

- Exceeding these ratings may damage the device.
- The maximum allowable power dissipation is a function of the maximum junction temperature T_J (MAX), the junction-to-ambient thermal resistance θ_{JA}, and the ambient temperature T_A. The maximum allowable continuous power dissipation at any ambient temperature is calculated by P_D (MAX) = (T_J (MAX) - T_A) / θ_{JA}. Exceeding the maximum allowable power dissipation can produce an excessive die temperature, and the device may go into thermal shutdown. Internal thermal shutdown circuitry protects the device from permanent damage.
- The device is not guaranteed to function outside of its operating conditions.
- If V_{IN} is close to V_{OUT}, then the boost converter may trigger the minimum on time (t_{ON}). If V_{IN} exceeds V_{OUT}, then the boost converter switches between boost mode and linear charge mode. Both conditions can result in an exceedingly high output voltage ripple (ΔV_{OUT}); therefore, it is not recommended to have V_{IN} exceed V_{OUT}.
- Measured on JESD51-7, 4-layer PCB.

ELECTRICAL CHARACTERISTICS

$V_{IN} = V_{EN} = 3.3V$, $V_{OUT} = 5V$, $T_J = -40^{\circ}C$ to $+125^{\circ}C$, typical values are tested at $T_J = 25^{\circ}C$, unless otherwise noted.

Parameters	Symbol	Condition	Min	Typ	Max	Units
Input Voltage Range						
Supply current	I_{Q_OUT}	$V_{MODE} = V_{EN} = V_{IN} = 3.3V, V_{OUT} = 6V$, no load, measured on OUT, $T_J = 25^{\circ}C$		52	80	μA
Quiescent current	I_{Q_IN}	$V_{MODE} = V_{EN} = V_{IN} = 3.3V, V_{OUT} = 6V$, $T_J = 25^{\circ}C$, no load, measured on VIN		8	14	μA
Shutdown current	I_{SD}	$V_{EN} = V_{OUT} = 0V, T_J = 25^{\circ}C$, measured on VIN		0.1	1	μA
V_{IN} under-voltage lockout (UVLO) threshold	V_{IN_UVLO}	V_{IN} rising, $T_J = 25^{\circ}C$.		1.65	1.7	V
V_{IN} UVLO hysteresis				100		mV
Step-Up Converter						
Switching frequency	f_{SW}		1.9	2.2	2.5	MHz
Reference voltage	V_{REF}	$T_J = 25^{\circ}C$	4.9	5	5.1	V
		$T_J = -40^{\circ}C$ to $125^{\circ}C$	4.875	5	5.125	V
Low-side MOSFET (LS-FET) on resistance	$R_{DS(ON)_LS}$			70		m Ω
LS-FET leakage current	I_{LKG_LS}	$V_{SW} = 6.5V, T_J = 25^{\circ}C$		0.1	1	μA
High-side MOSFET (HS-FET) on resistance	$R_{DS(ON)_HS}$			80		m Ω
HS-FET leakage current	I_{LKG_PMOS}	$V_{SW} = 6.5V, V_{OUT} = 0V, T_J = 25^{\circ}C$		0.1	1	μA
Maximum duty cycle	D_{MAX}	$V_{IN} = 3.3V$		85		%
Start-up current limit	I_{LIMIT_SU}	$V_{IN} = 4V, V_o = 0V$	0.1	0.3	0.4	A
		$V_{IN} = 4V, V_{OUT}$ is set to 3.6V, pull V_{OUT} to 3.3V	0.4	0.8	1	A
LS-FET current limit	I_{LIMIT_LS}	40% duty cycle	2.5	3.6	4.5	A
Logic Interface						
Enable (EN) high voltage	V_{EN_HIGH}		1.2			V
EN low voltage	V_{EN_LOW}				0.4	V
EN current	I_{EN}	Connected to V_{IN}		10		nA
Thermal Protections						
Thermal shutdown ⁽⁶⁾	T_{SD}		150	160	175	$^{\circ}C$
Thermal shutdown hysteresis ⁽⁶⁾				25		$^{\circ}C$

Note:

6) Guaranteed by characterization. Not production tested.

TYPICAL PERFORMANCE CHARACTERISTICS

$V_{IN} = 3.3V$, $V_{OUT} = 5V$, $L = 0.68\mu H$, $T_A = 25^\circ C$, unless otherwise noted.

Efficiency vs. Load Current

AAM mode

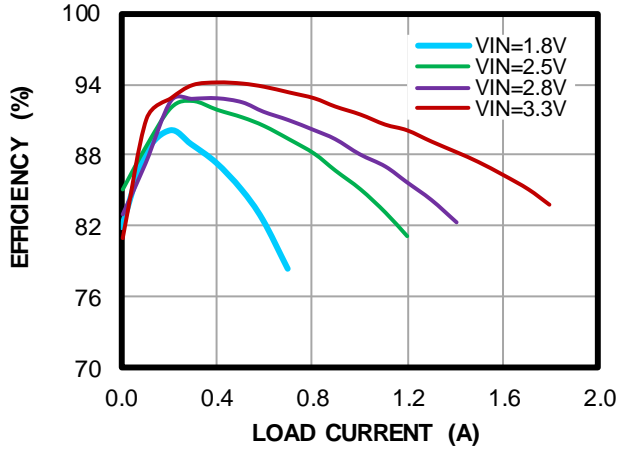

Efficiency vs. Input Voltage

AAM mode

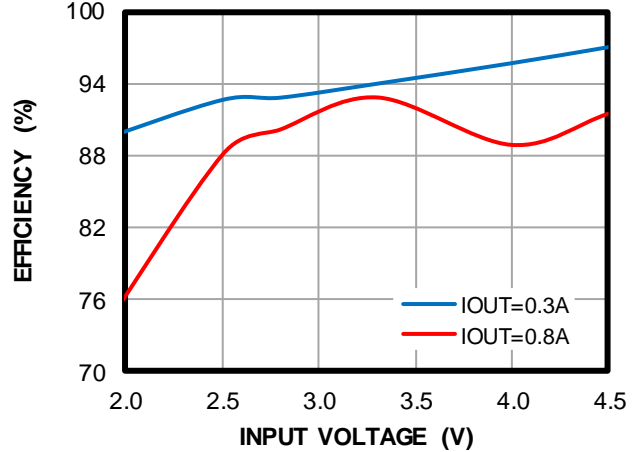

Load Regulation

AAM mode

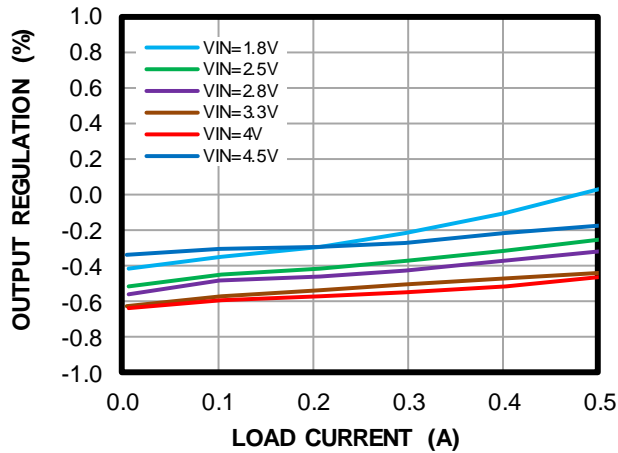

Line Regulation

AAM mode

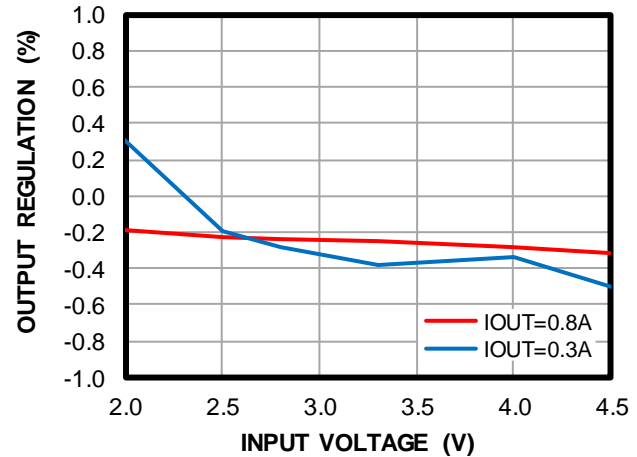

Efficiency vs. Load Current

FCCM

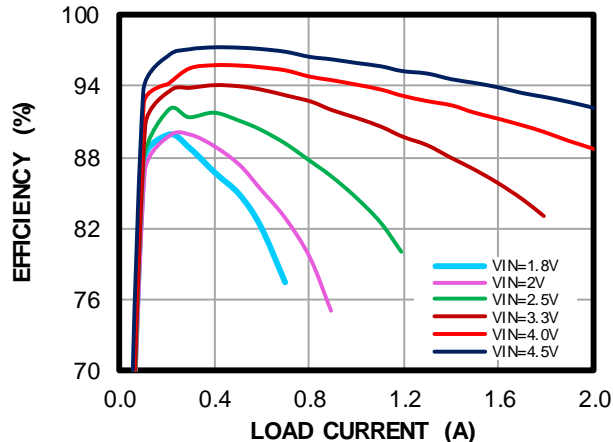

Efficiency vs. Input Voltage

FCCM

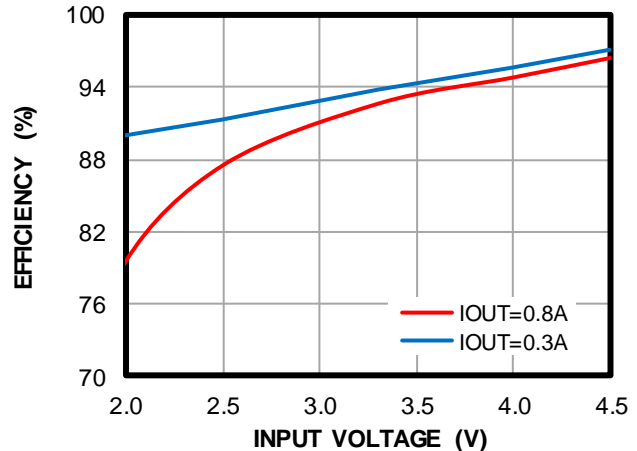

TYPICAL PERFORMANCE CHARACTERISTICS (continued)

$V_{IN} = 3.3V$, $V_{OUT} = 5V$, $L = 0.68\mu H$, $T_A = 25^\circ C$, unless otherwise noted.

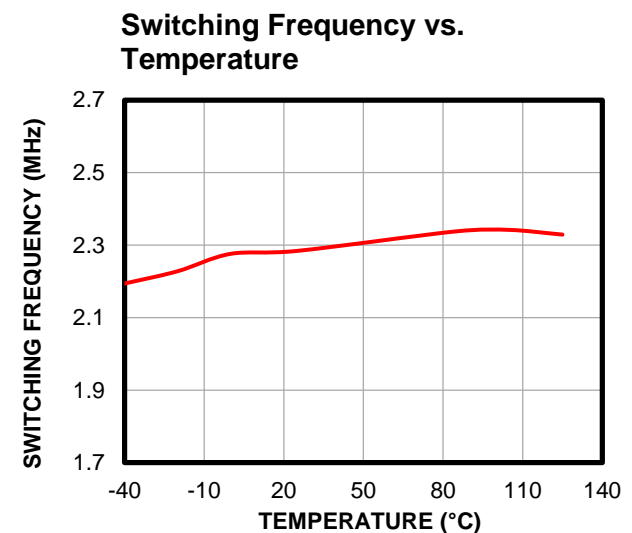
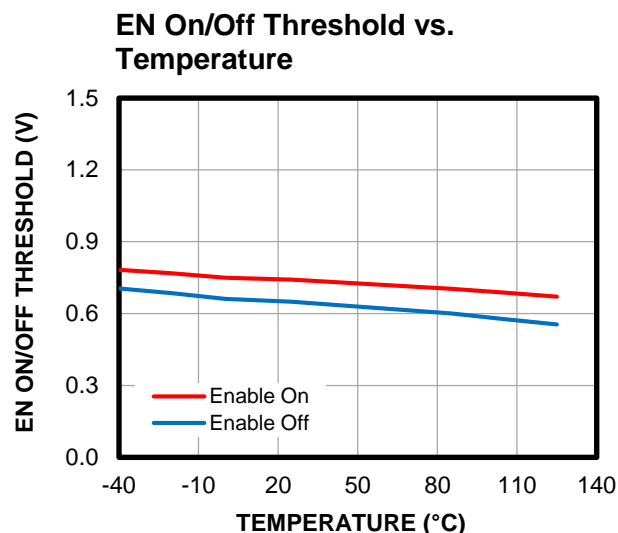
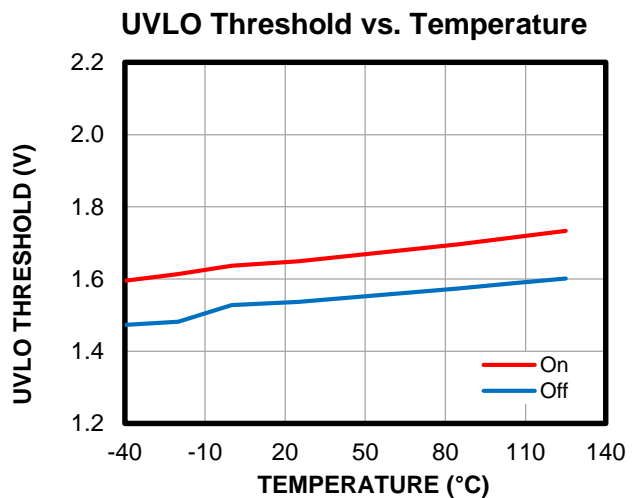
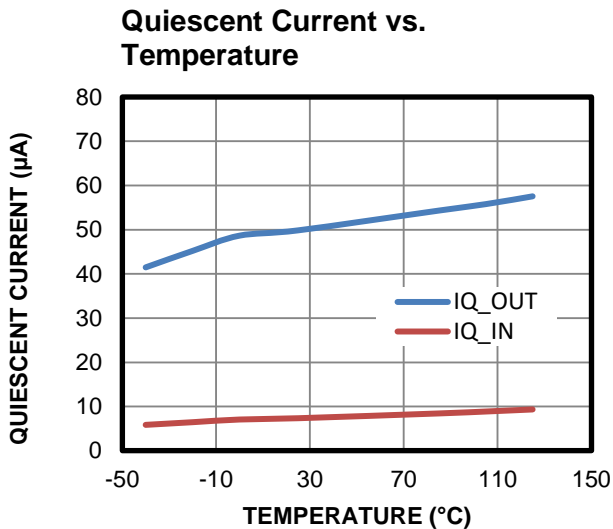
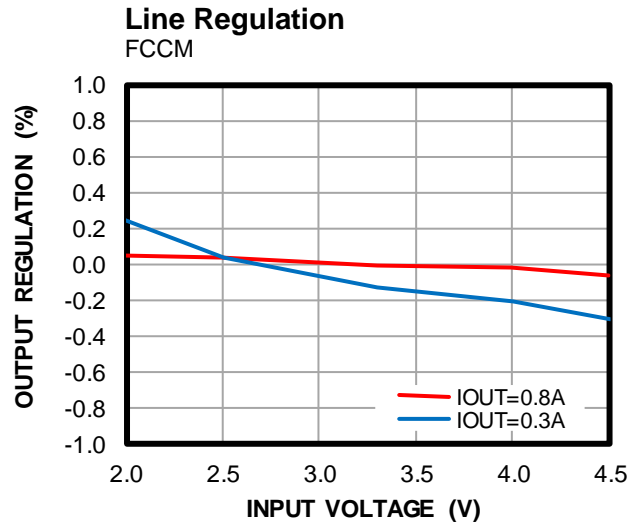
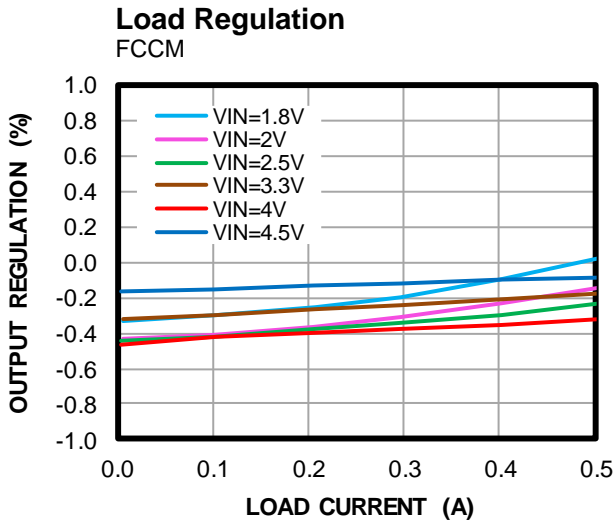

TYPICAL PERFORMANCE CHARACTERISTICS *(continued)*

$V_{IN} = 3.3V$, $V_{OUT} = 5V$, $L = 0.68\mu H$, $T_A = 25^\circ C$, unless otherwise noted.

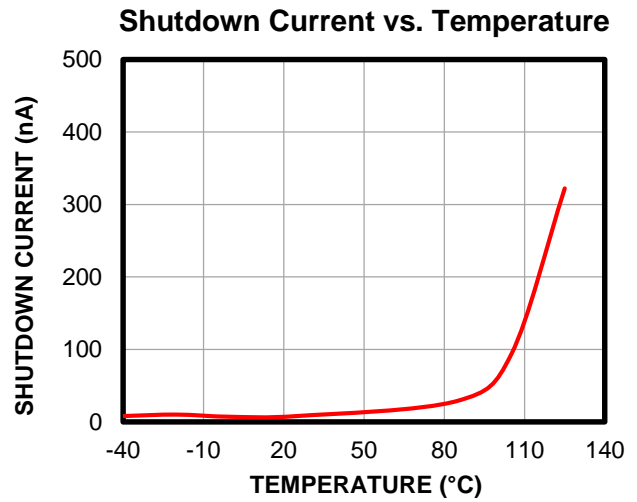
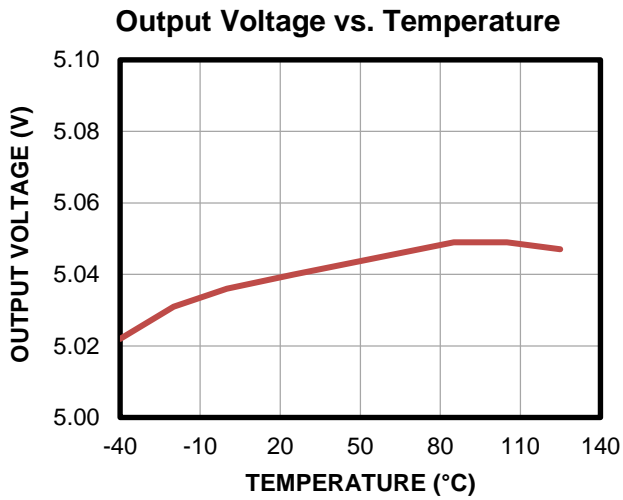

TYPICAL PERFORMANCE CHARACTERISTICS (continued)

$V_{IN} = 3.3V$, $V_{OUT} = 5V$, $L = 0.68\mu H$, $T_A = 25^\circ C$, unless otherwise noted.

Steady State

AAM mode, $V_{IN} = 2.5V$, $I_{OUT} = 0A$

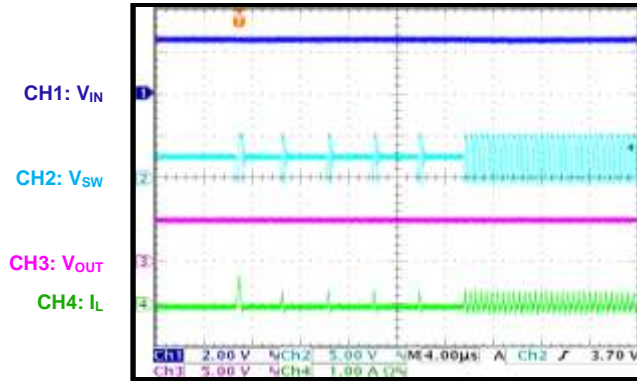

Steady State

AAM mode, $V_{IN} = 2.5V$, $I_{OUT} = 0.6A$

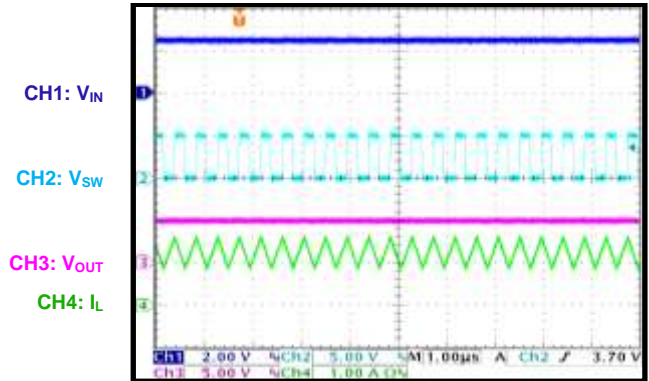

Steady State

AAM mode, $V_{IN} = 2.5V$, $I_{OUT} = 1.2A$

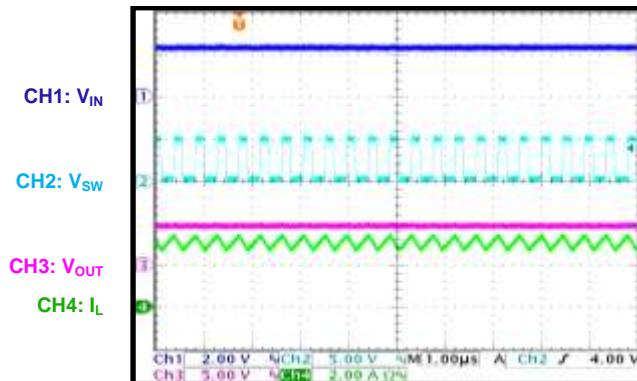

Steady State

FCCM, $V_{IN} = 2.5V$, $I_{OUT} = 0A$

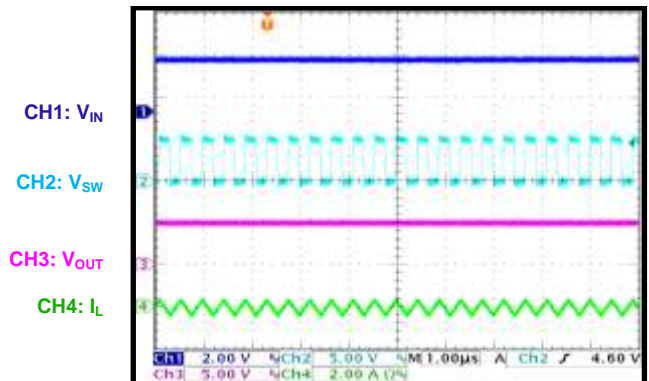

Steady State

FCCM, $V_{IN} = 2.5V$, $I_{OUT} = 0.6A$

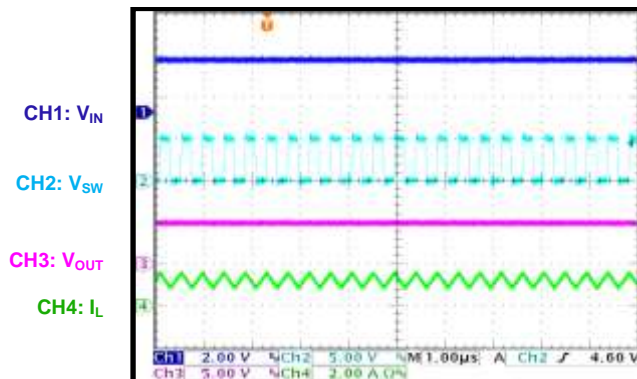

Steady State

FCCM, $V_{IN} = 2.5V$, $I_{OUT} = 1.2A$

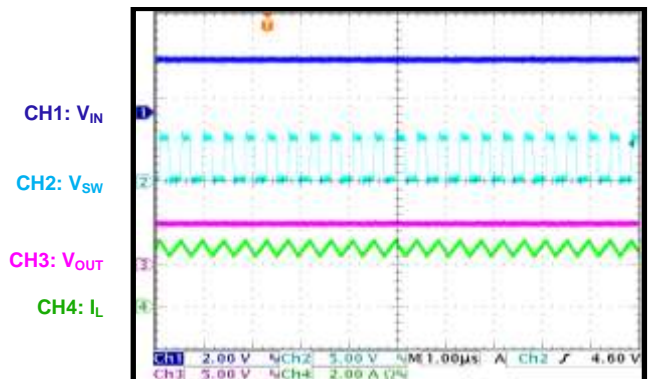

TYPICAL PERFORMANCE CHARACTERISTICS (continued)

$V_{IN} = 3.3V$, $V_{OUT} = 5V$, $L = 0.68\mu H$, $T_A = 25^\circ C$, unless otherwise noted.

Start-Up through VIN

FCCM, $V_{IN} = 3.3V$, $I_{OUT} = 1A$

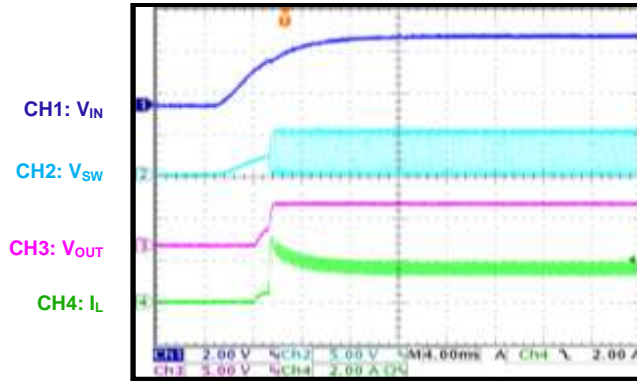

Shutdown through VIN

FCCM, $V_{IN} = 3.3V$, $I_{OUT} = 1A$

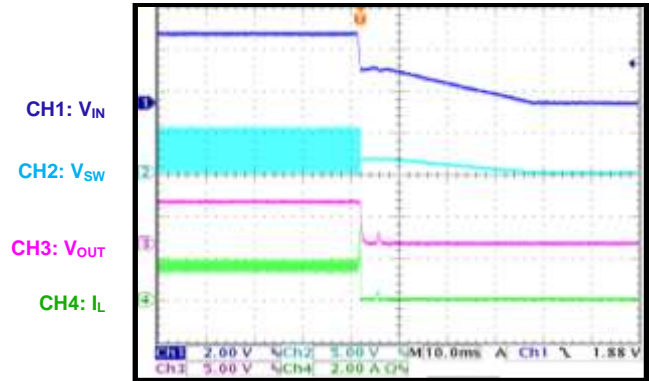

Start-Up through EN

FCCM, $V_{IN} = 3.3V$, $I_{OUT} = 0.5A$

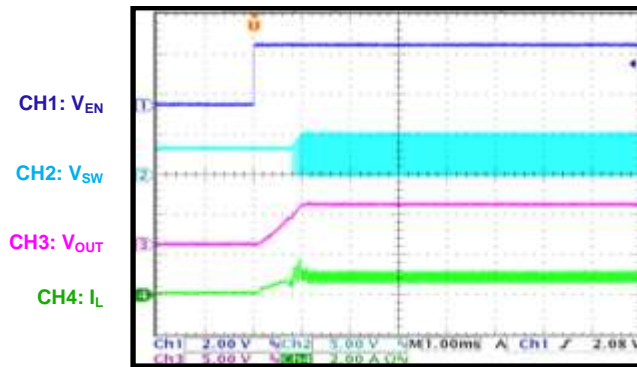

Shutdown through EN

FCCM, $V_{IN} = 3.3V$, $I_{OUT} = 0.5A$

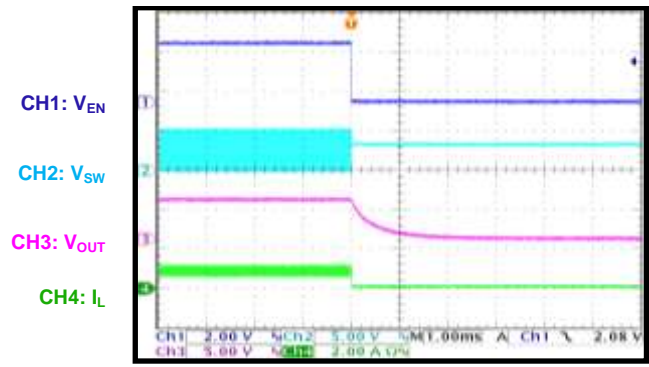

Load Transient

FCCM, $V_{IN} = 3.3V$, $I_{OUT} = 0A$ to $1A$,
2.5A/ μs slew rate

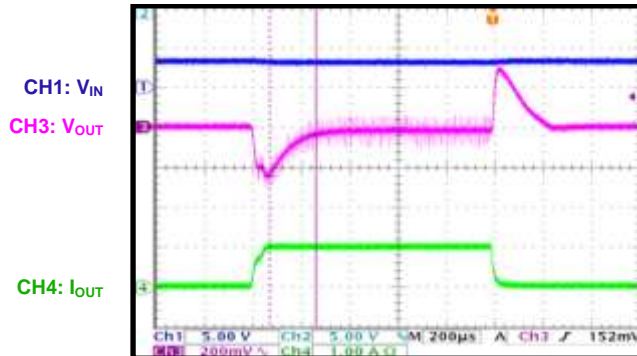

Short-Circuit Protection

FCCM, $V_{IN} = 3.3V$, $I_{OUT} = 0.5A$

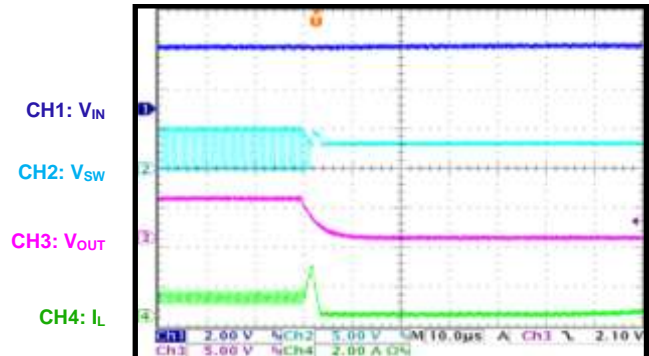

TYPICAL PERFORMANCE CHARACTERISTICS *(continued)*

$V_{IN} = 3.3V$, $V_{OUT} = 5V$, $L = 0.68\mu H$, $T_A = 25^\circ C$, unless otherwise noted.

SCP Recovery

FCCM, $V_{IN} = 3.3V$, $I_{OUT} = 0.5A$

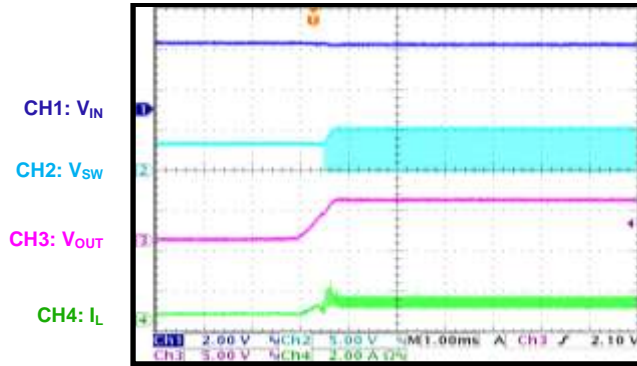

Over-Voltage Protection

$V_{IN} = 2.5V$, $I_{OUT} = 0.5A$

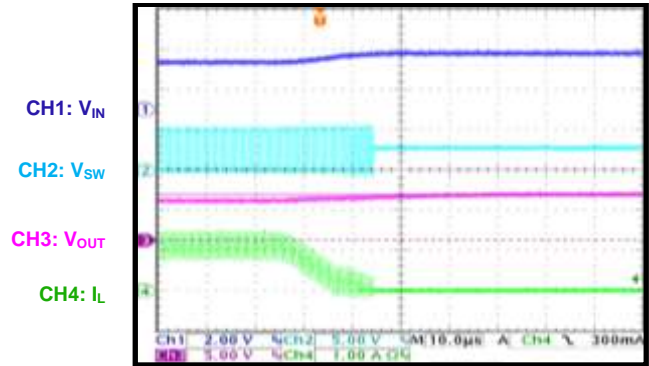

OVP Recovery

$V_{IN} = 2.5V$, $I_{OUT} = 0.5A$

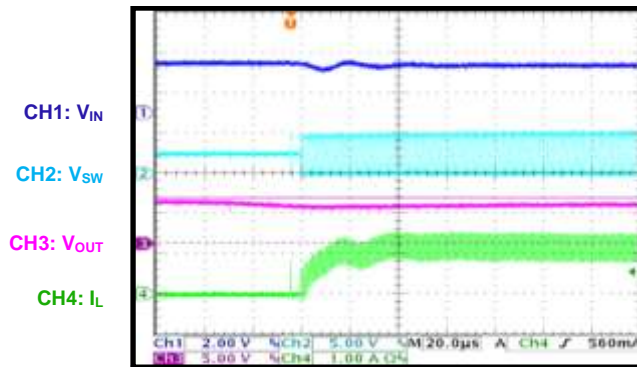

FUNCTIONAL BLOCK DIAGRAM

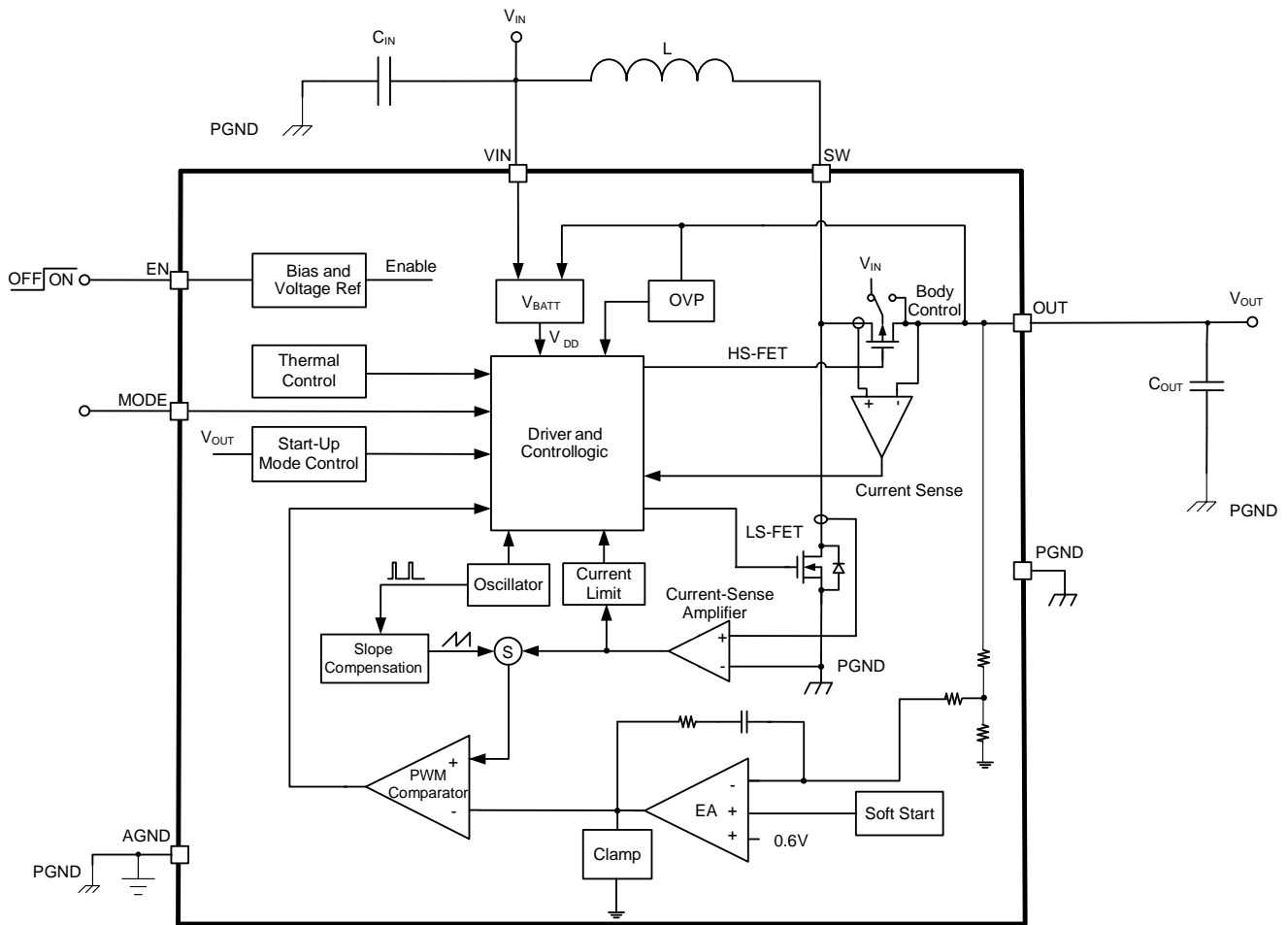

Figure 1: Functional Block Diagram

OPERATION

The MPQ3414B is a 2.2MHz, synchronous step-up converter with output disconnect. The device's fixed switching frequency (f_{SW}) and pulse-width modulation (PWM) mode control provide good load and line regulation. Internal soft start (SS) and loop compensation simplify the design process and minimize the number of external components. The internal, low on resistance MOSFETs and frequency stretching allow the MPQ3414B to maintain high efficiency across a wide current load range.

Start-Up

The MPQ3414B can start up in linear charge mode. In the linear charge mode, the rectified P-channel high-side MOSFET (HS-FET) turns on until the output voltage (V_{OUT}) reaches close to the input voltage (V_{IN}). To avoid inrush current, the HS-FET current (I_{HS}) is limited. If V_{OUT} is 0V, then I_{HS} is limited to about 0.3A. If V_{IN} exceeds 3.3V, then I_{HS} is limited to about 0.8A as V_{OUT} rises to 3.3V. This limits the output current (I_{OUT}) during a short circuit. Once V_{OUT} reaches V_{IN} , the device starts up once the linear charge time is complete. V_{OUT} starts to rise under the control of the internal soft start (SS). In boost mode, I_{HS} is limited to 3.6A.

If V_{OUT} exceeds V_{IN} , then the MPQ3414B uses V_{OUT} to power the internal circuitry instead of V_{IN} . This allows the device to operate at high efficiency, with strong driving capabilities. If V_{IN} drops to 2.8V, the device uses V_{OUT} to power the internal circuitry.

Soft Start (SS)

The MPQ3414B provides soft start (SS) via an internal capacitor with a current source. During linear charge mode, the SS voltage (V_{SS}) rises according to the feedback (FB) voltage (V_{FB}). Once the linear charge time is complete, the V_{SS} is charged and the reference voltage (V_{REF}) ramps up according to the fixed internal slew rate. The SS capacitor (C_{SS}) is discharged completely if the device shuts down, thermal shutdown is triggered, or there is a short circuit.

Enable (EN)

Pull the enable (EN) pin above 1.2V to turn the converter on; pull EN below 0.4V to turn it off. During shutdown, the converter stops switching, the internal control circuitry turns off, and the

output disconnects from the input.

Power-Save Mode (PSM)

If the MODE pin is pulled logic high as the load decreases, then the device enters power-save mode (PSM). The converter switches back to PWM mode as the load increases. In PSM, f_{SW} decreases to reduce switching and driver losses. f_{SW} also decreases if V_{IN} is close to V_{OUT} . If f_{SW} remains at a 2.2MHz, then the minimum on time (t_{ON}). This decreases the output voltage ripple (ΔV_{OUT}) by avoiding group-pulse mode. Under extremely light-load conditions, the MPQ3414B operates in group-pulse mode to regulate V_{OUT} and save power.

If MODE is pulled to logic low, then the device enters forced continuous conduction mode (FCCM). In FCCM, f_{SW} remains fairly constant across the entire load range.

It is not recommended to adjust the MODE pin during operation, as doing so may lead to a disturbance on the output.

Error Amplifier (EA)

The MPQ3414B features an internal error amplifier (EA) with internal compensation. The EA compares the internal V_{REF} (0.6V) and V_{FB} to generate an EA signal to control V_{OUT} . V_{OUT} is fixed at 5V.

Current Sense

In linear charge mode, I_{HS} is sensed and compared to the current limit threshold (I_{LIMIT_HS}). The compared output manages the I_{HS} .

In boost mode, lossless current sensing converts the N-channel low-side MOSFET (LS-FET) switch current signal to a voltage that is added to the internal slope compensation. This signal is compared to the EA output to provide a peak current control command for PWM mode. The peak switch current is limited to about 3.6A. The switch current signal has an internal blanking time (60ns) to reduce noise.

Output Disconnect

The MPQ3414B eliminates the internal rectifier's body diode conduction to provide output disconnect. This allows V_{OUT} to drop to 0V during shutdown, which draws a zero current from the input source. This allows

for inrush current limiting during start-up, which minimizes the surge current at the input. To use output disconnect, an external Schottky diode cannot be connected between the SW and OUT pins.

Overload Protection (OLP) and Short-Circuit Protection (SCP)

If an overload fault or a short circuit occurs, V_{OUT} drops. If V_{OUT} drops below V_{IN} (0.3V), then the converter shuts down. It starts up again in linear charge mode after a set delay time (50 μ s). If the overload fault or short circuit is removed, then the device initiates an SS and resumes normal operation.

Over-Voltage Protection (OVP)

If V_{OUT} exceeds 6V, then converter turns off. Once V_{OUT} drops to about 5.7V, the converter recovers automatically and resumes normal operation. This protects the internal MOSFET from over-voltage stress.

Thermal Shutdown

The device monitors the die temperature internally. If the die temperature exceeds the thermal shutdown threshold (about 155°C), the converter shuts down. Once the temperature drops below 130°C, the converter initiates a SS and resumes normal operation.

APPLICATION INFORMATION

Selecting the Input Capacitor (C_{IN})

Low-ESR input capacitors reduce input switching noise and the peak current drawn from the battery. Ceramic capacitors are recommended for input decoupling, and should be placed as close to the IC as possible. It is recommended to use a >10µF ceramic capacitor to limit the V_{IN} ripple (ΔV_{IN}).

Selecting the Output Capacitor (C_{OUT})

To ensure stability across the entire operating range, place an ≥22µF output capacitor (C_{OUT}) on the OUT pin. A higher capacitance may be required to decrease the V_{OUT} and the transient ripple. Low-ESR capacitors with X5R or X7R type dielectrics are recommended. The output minimum C_{OUT} required to support the ripple in PWM mode (C_{OUT_MIN}) can be calculated with Equation (2):

$$C_{OUT_MIN} \geq \frac{I_{OUT} \times (V_{OUT_MAX} - V_{IN_MIN})}{f_{SW} \times V_{OUT_MAX} \times \Delta V_{OUT}} \quad (2)$$

Where the ESR is 0Ω, V_{OUT_MAX} is the maximum V_{OUT}, V_{IN_MIN} is the minimum V_{IN}, and ΔV_{OUT} is the acceptable V_{OUT} ripple.

Place a 1µF ceramic between the OUT and PGND pins using a short loop to reduce EMI and voltage spikes on the SW pin.

Selecting the Inductor

The MPQ3414B utilizes small, surface-mounted inductors due to its 2.2MHz f_{SW}. A 0.47µH to 1.2µH inductor is suitable for most applications.

A larger-value inductor allows for greater I_{OUT} capabilities by reducing the inductor ripple current; however, a larger inductor has a larger physical size. The minimum inductance (L) can be calculated with Equation (3):

$$L \geq \frac{V_{IN_MIN} \times (V_{OUT_MAX} - V_{IN_MIN})}{V_{OUT_MAX} \times \Delta I_L \times f_{SW}} \quad (3)$$

Where ΔI_L is the acceptable inductor current (I_L) ripple.

ΔI_L is typically set between to 30% and 50% of the maximum I_L (I_{L_MAX}). Keep the series resistance of the inductor low to reduce resistive power loss. The saturated current (I_{SAT}) should be large enough to support the peak current.

Design Example

Table 1 shows a design example following the application guidelines for the specifications below.

Table 1: Design Example

V _{IN}	2.8V to 4V
V _{OUT}	5V
I _{OUT} (Peak)	1A
I _{OUT} (Average)	0.5A

Figure 3 on page 16 shows a typical application circuit for a 5V output. For more device applications, refer to the related evaluation board.

PCB Layout Guidelines

Efficient PCB layout is critical for stable operation. Poor layout can result in reduced performance, excessive EMI, resistive loss, system instability, and over-voltage stress. For the best results, refer to Figure 2 and follow the guidelines below:

1. Place the output capacitor as close to the OUT pin as possible, and close to PGND.
2. Place a small decoupling capacitor in parallel with the bulk output capacitor.
3. Place the small decoupling capacitor as close to the OUT and PGND pins as possible to reduce EMI and voltage spikes on SW.
4. Place the input capacitor and inductor as close to the VIN and SW pins as possible using short and wide traces.
5. Place the feedback loop far away from any noisy nodes (such as SW).

6. Place the feedback resistor divider as close to the feedback node and AGND as possible.
7. Place the ground return of the input and output capacitors as close to PGND as possible using a large copper ground area and multiple vias to improve thermal performance.

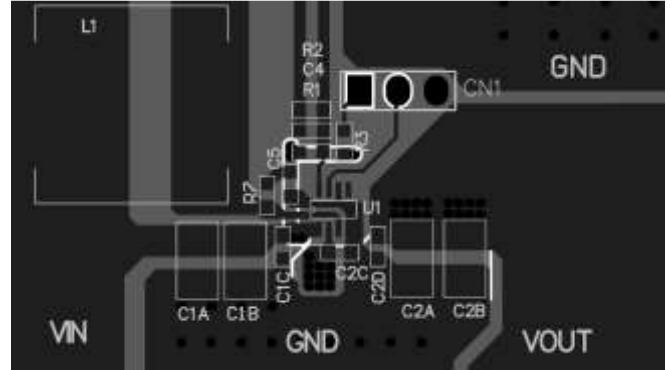

Figure 2: Recommended PCB Layout

TYPICAL APPLICATION CIRCUIT

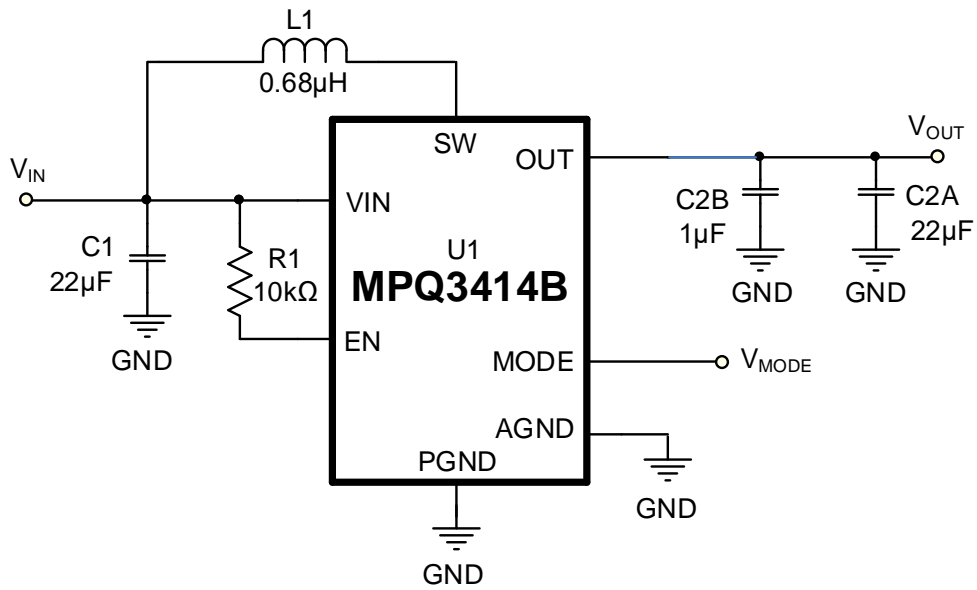

Figure 3: Typical Application Circuit ($V_{IN} = 2.8V$ to $4V$, $V_{OUT} = 5V$, $I_{OUT} = 0.5A$, $I_{OUT_PEAK} = 1A$) ⁽⁷⁾

Note:

7) The AGND and PGND pins are connected together in application.

PACKAGE INFORMATION

TSOT23-8

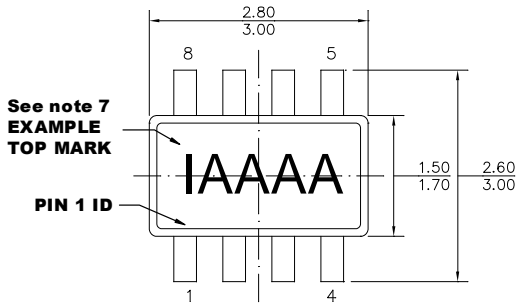

TOP VIEW

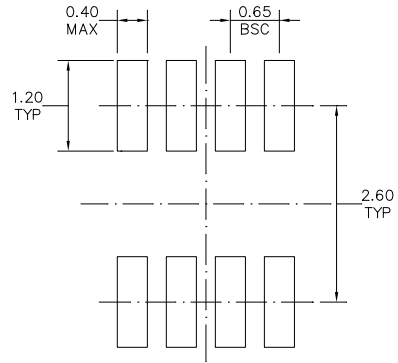

RECOMMENDED LAND PATTERN

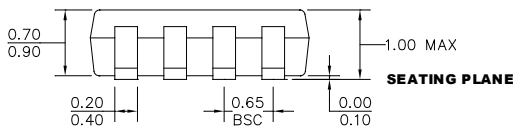

FRONT VIEW

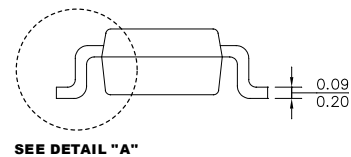

SIDE VIEW

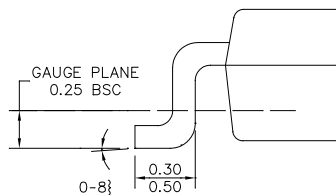

DETAIL "A"

NOTE:

- 1) ALL DIMENSIONS ARE IN MILLIMETERS.
- 2) PACKAGE LENGTH DOES NOT INCLUDE MOLD FLASH, PROTRUSION, OR GATE BURR.
- 3) PACKAGE WIDTH DOES NOT INCLUDE INTERLEAD FLASH OR PROTRUSION.
- 4) LEAD COPLANARITIES (BOTTOM OF LEADS AFTER FORMING) SHALL BE 0.1 MILLIMETERS MAX.
- 5) JEDEC REFERENCE IS MO-193, VARIATION BA.
- 6) DRAWING IS NOT TO SCALE.
- 7) PIN 1 IS THE LOWER LEFT PIN WHEN READING THE TOP MARK FROM LEFT TO RIGHT (SEE EXAMPLE TOP MARK).

CARRIER INFORMATION

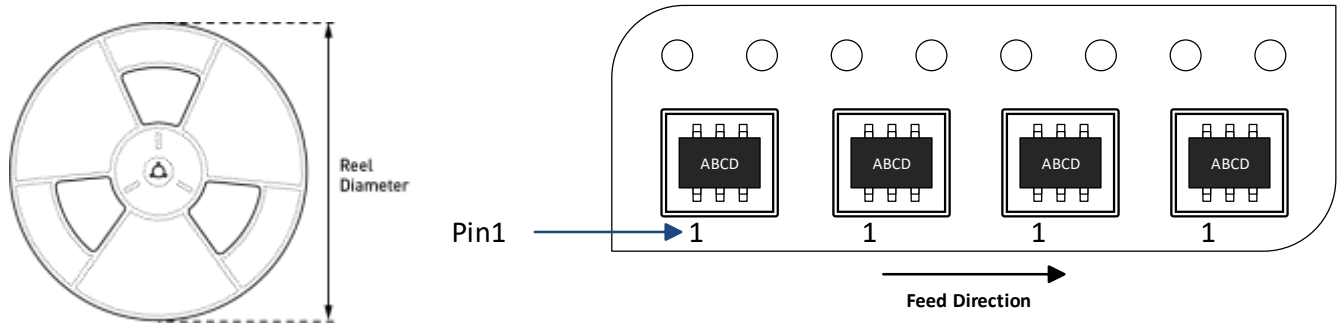

Part Number	Package Description	Quantity/ Reel	Quantity/ Tube	Quantity/ Tray	Reel Diameter	Carrier Tape Width	Carrier Tape Pitch
MPQ3414BGJ-5-AEC1-Z	TSOT23-8	3000	N/A	N/A	7in	8mm	4mm

REVISION HISTORY

Revision #	Revision Date	Description	Pages Updated
1.0	2/9/2022	Initial Release	-

Notice: The information in this document is subject to change without notice. Please contact MPS for current specifications. Users should warrant and guarantee that third-party Intellectual Property rights are not infringed upon when integrating MPS products into any application. MPS will not assume any legal responsibility for any said applications.