

MAQ5282

Typical Application Circuits

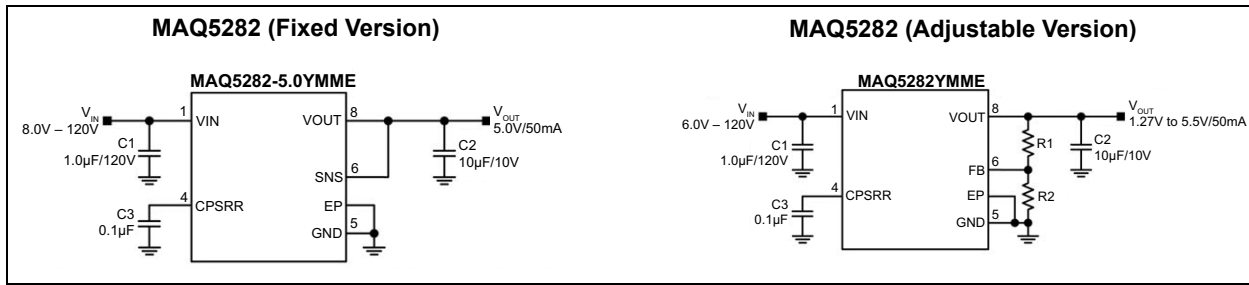

Functional Block Diagrams

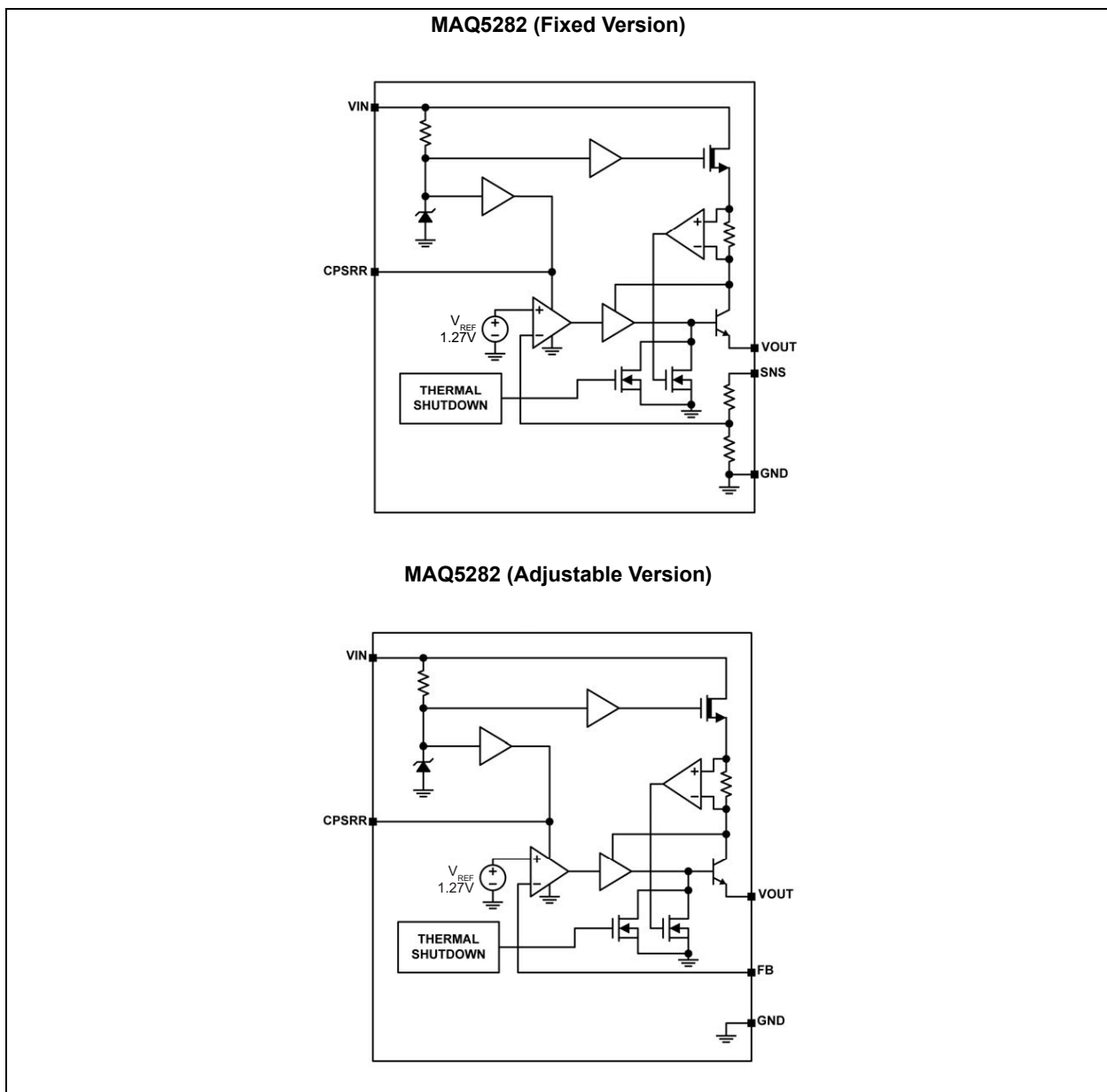

1.0 ELECTRICAL CHARACTERISTICS

Absolute Maximum Ratings †

V_{IN} to GND	-0.3V to +125V
V_{CPSRR} to GND	-0.3V to +14V
V_{FB} , V_{SNS} , V_{OUT} to GND	-0.3V to +6V
Power Dissipation (P_D , Note 1)	Internally Limited
ESD Ratings (Note 2)	
HBM	2 kV
MM	200V

Operating Ratings ‡

V_{IN}	+6V to +120V
V_{OUT} Adjust Range	+1.27V to +5.5V

† **Notice:** Stresses above those listed under “Absolute Maximum Ratings” may cause permanent damage to the device. This is a stress rating only and functional operation of the device at those or any other conditions above those indicated in the operational sections of this specification is not intended. Exposure to maximum rating conditions for extended periods may affect device reliability.

‡ **Notice:** The device is not guaranteed to function outside its operating ratings.

Note 1: The maximum allowable power dissipation at any T_A (ambient temperature) is $P_{D(MAX)} = (T_{J(MAX)} - T_A)/\theta_{JA}$. Exceeding the maximum allowable power dissipation results in excessive die temperature, and causes the regulator to enter thermal shutdown.

2: Devices are ESD sensitive; use proper handling precautions. Human body model, 1.5 k Ω in series with 100 pF.

ELECTRICAL CHARACTERISTICS

Electrical Characteristics: $V_{IN} = 12V$, $C_{IN} = 1.0 \mu F$, $C_{PSRR} = 0.1 \mu F$, $C_{OUT} = 10 \mu F$, $I_{OUT} = 100 \mu A$, $T_A = +25^\circ C$, **bold** values valid for $-40^\circ C \leq T_J \leq +125^\circ C$, unless noted. (Note 1)

Parameter	Symbol	Min.	Typ.	Max.	Units	Conditions
Power Supply Input						
Input Voltage Range	V_{IN}	6	—	120	V	Note 2
Quiescent Supply Current	I_Q	—	6	11	μA	$I_{OUT} = 0$, Note 3
Output Voltage						
Output Voltage	V_{OUT}	1.27	—	5.5	V	Adjustable version
		3.2	3.3	3.4		Fixed 3.3V version
		3.13	3.3	3.47		Fixed 5.0 version
		4.85	5.0	5.15		
		4.75	5.0	5.25		
Output Voltage Accuracy	—	-3	—	+3	%	Variation from nominal V_{OUT}
		-5	—	+5		
Load Regulation	$\frac{\Delta V_{OUT}}{V_{OUT}}$	-1.0	0.5	+1.0	%	$I_{OUT} = 100 \mu A$ to 50 mA
Line Regulation	$\frac{\Delta V_{OUT}}{(V_{OUT} \times \Delta V_{IN})}$	-0.5	0.04	+0.5	%/V	$V_{IN} = 10V$ to 120V, Note 4
Feedback Input (Adjustable Version)						
Feedback Voltage	V_{FB}	1.232	1.270	1.308	V	—
		1.206	1.270	1.333		
Feedback Current	I_{FB}	—	3.2	—	nA	$V_{FB} = 1.27V$

MAQ5282

ELECTRICAL CHARACTERISTICS (CONTINUED)

Electrical Characteristics: $V_{IN} = 12V$, $C_{IN} = 1.0 \mu F$, $C_{PSRR} = 0.1 \mu F$, $C_{OUT} = 10 \mu F$, $I_{OUT} = 100 \mu A$, $T_A = +25^\circ C$, **bold values valid for $-40^\circ C \leq T_J \leq +125^\circ C$, unless noted. (Note 1)**

Parameter	Symbol	Min.	Typ.	Max.	Units	Conditions
Current Limit						
Current Limit	I_{LIM}	60	125	260	mA	$V_{OUT} = 0V$
Ripple Rejection						
Power Supply Rejection Ratio	PSRR	—	80	—	dB	$f = 20 \text{ kHz to } 1 \text{ MHz}$
Power Dropout Voltage						
Dropout Voltage	V_{DO}	—	2	3	V	$I_{OUT} = 50 \text{ mA}$
Thermal Protection						
Thermal Shutdown Temperature	T_{SHDN}	—	157	—	$^\circ C$	T_J rising
Thermal Shutdown Hysteresis	$T_{SD \text{ HYS}}$	—	15	—	$^\circ C$	—

Note 1: Specifications are for packaged products only.

2: Ensure that $V_{IN} \geq (V_{OUT} + 3V)$ and $V_{IN} \geq 6V$.

3: Quiescent current is specified for the adjustable option. The fixed options will add approximately $1 \mu A$ due to the internal feedback resistors.

4: Line regulation is a percentage of V_{OUT} .

TEMPERATURE SPECIFICATIONS

Parameters	Sym.	Min.	Typ.	Max.	Units	Conditions
Temperature Ranges						
Junction Temperature Range	T_J	-40	—	+125	$^\circ C$	Note 1
Storage Temperature Range	T_S	-65	—	+150	$^\circ C$	—
Lead Temperature	—	—	—	+260	$^\circ C$	Soldering, 10s
Package Thermal Resistances						
Thermal Resistance, MSOP 8-LD	θ_{JA}	—	64	—	$^\circ C/W$	—

Note 1: The maximum allowable power dissipation is a function of ambient temperature, the maximum allowable junction temperature and the thermal resistance from junction to air (i.e., T_A , T_J , θ_{JA}). Exceeding the maximum allowable power dissipation will cause the device operating junction temperature to exceed the maximum $+125^\circ C$ rating. Sustained junction temperatures above $+125^\circ C$ can impact the device reliability.

2.0 TYPICAL PERFORMANCE CURVES

Note: The graphs and tables provided following this note are a statistical summary based on a limited number of samples and are provided for informational purposes only. The performance characteristics listed herein are not tested or guaranteed. In some graphs or tables, the data presented may be outside the specified operating range (e.g., outside specified power supply range) and therefore outside the warranted range.

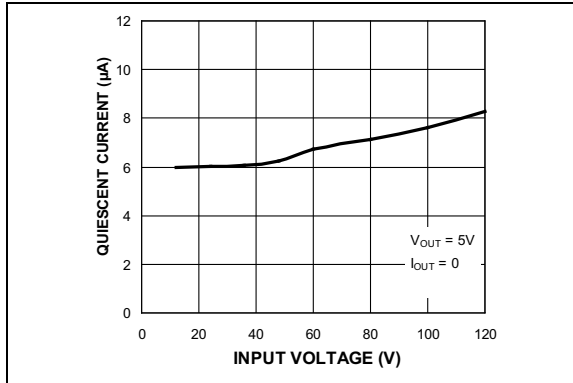

FIGURE 2-1: Quiescent Supply Current vs. Input Voltage.

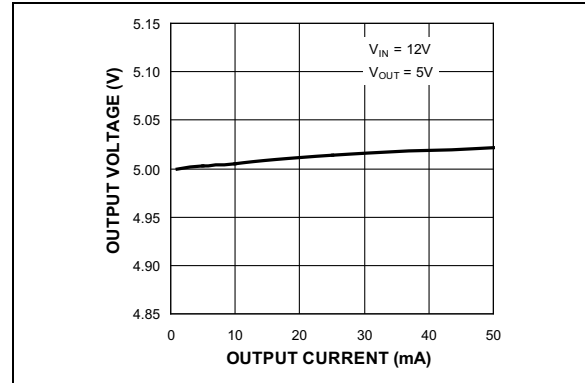

FIGURE 2-4: Output Voltage vs. Output Current.

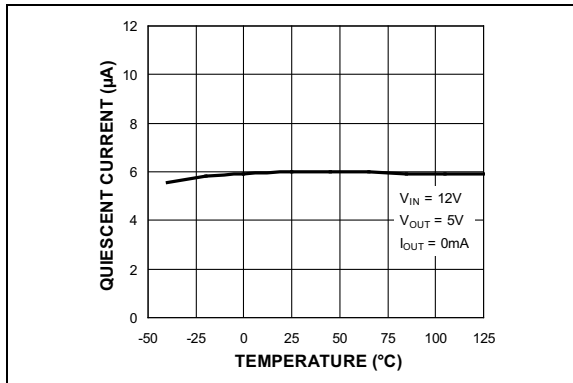

FIGURE 2-2: Quiescent Supply Current vs. Temperature.

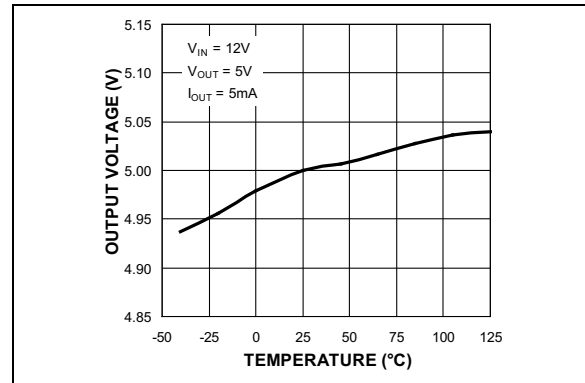

FIGURE 2-5: Output Voltage vs. Temperature.

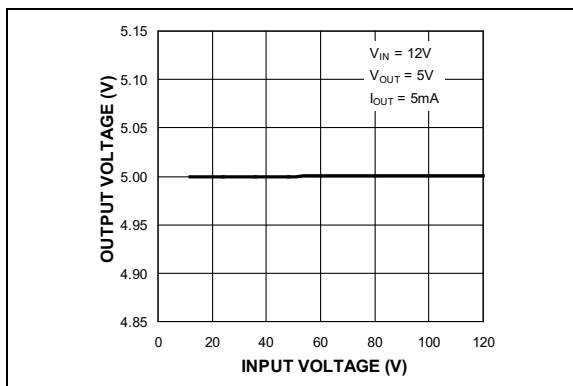

FIGURE 2-3: Output Voltage vs. Input Voltage.

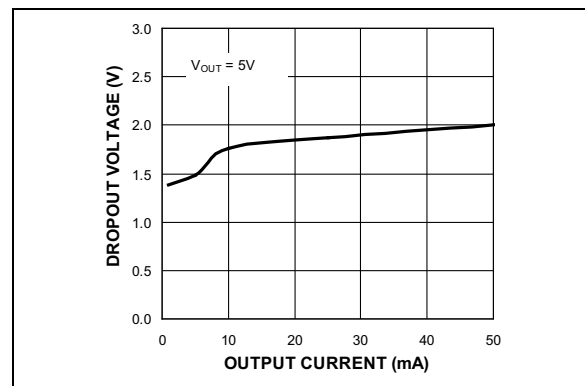

FIGURE 2-6: Dropout Voltage vs. Output Current.

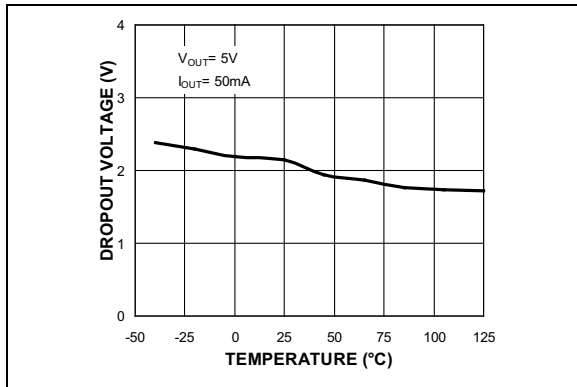

FIGURE 2-7: Dropout Voltage vs. Temperature.

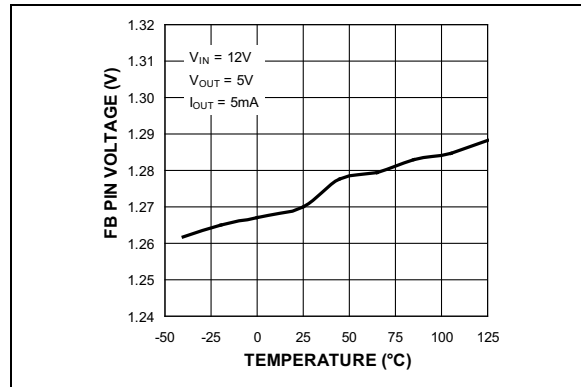

FIGURE 2-10: Feedback Pin Voltage vs. Temperature.

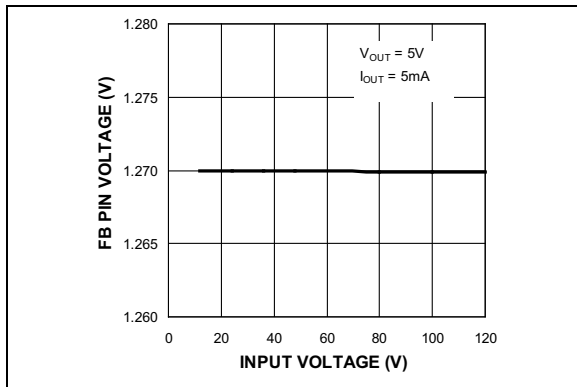

FIGURE 2-8: Feedback Pin Voltage vs. Input Voltage.

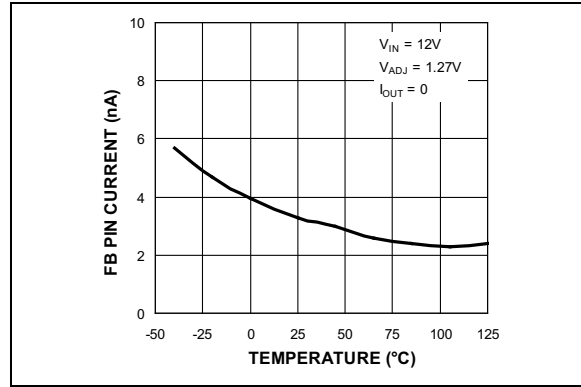

FIGURE 2-11: Feedback Pin Current vs. Temperature.

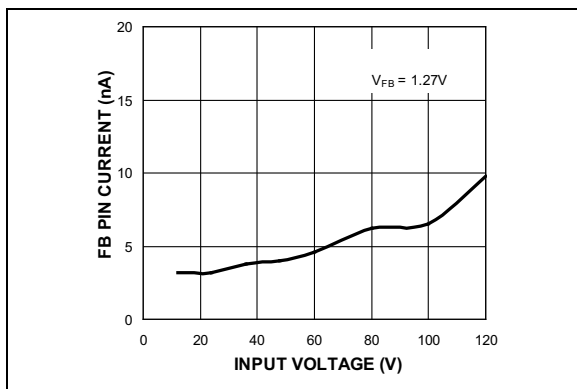

FIGURE 2-9: Feedback Pin Current vs. Input Voltage.

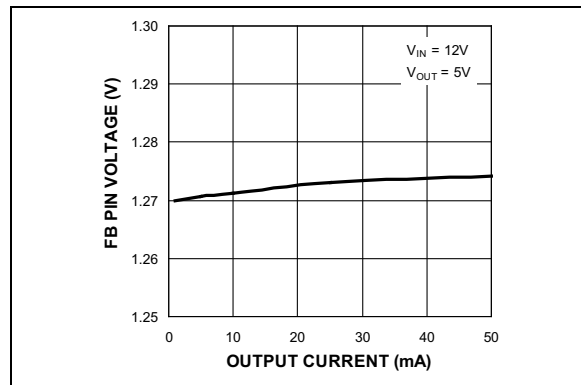

FIGURE 2-12: Feedback Pin Voltage vs. Output Current.

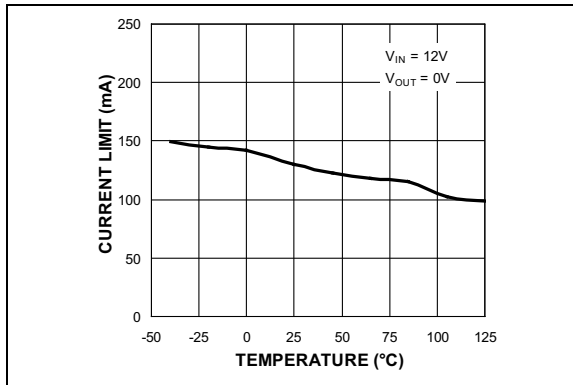

FIGURE 2-13: Current Limit vs. Temperature.

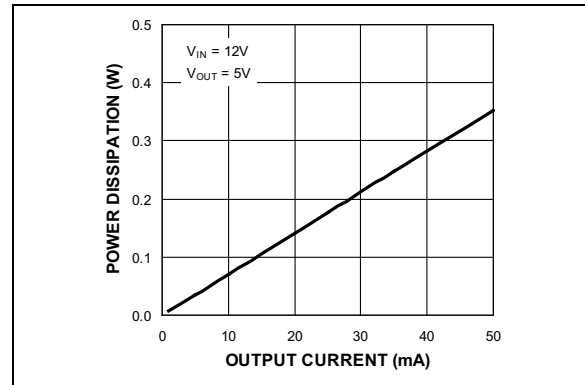

FIGURE 2-16: Power Dissipation vs. Output Current.

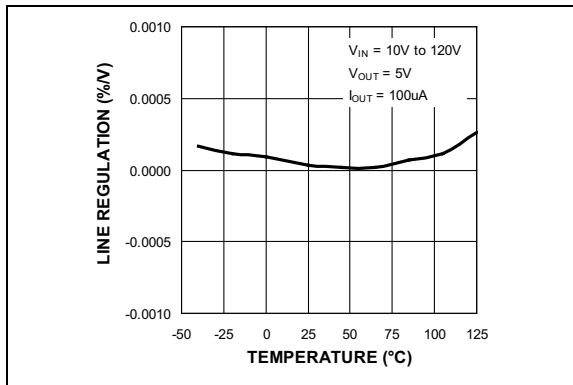

FIGURE 2-14: Line Regulation vs. Temperature.

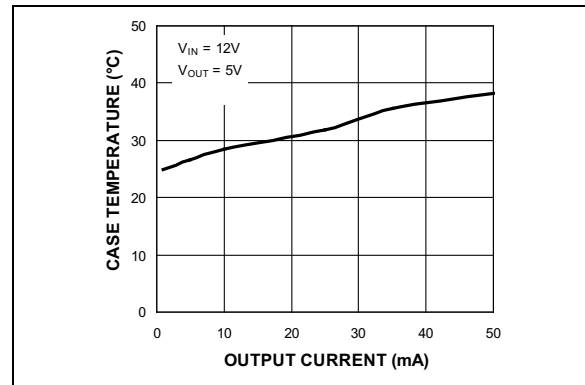

FIGURE 2-17: Case Temperature* vs. Output Current.

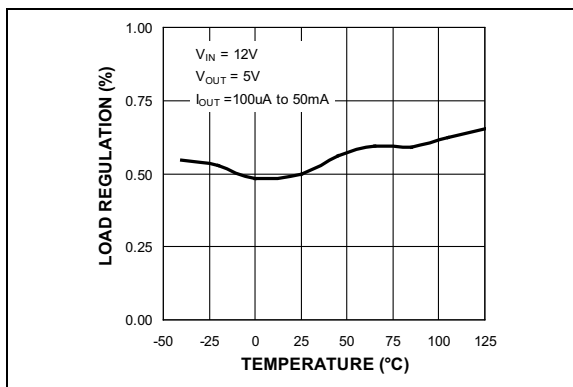

FIGURE 2-15: Load Regulation vs. Temperature.

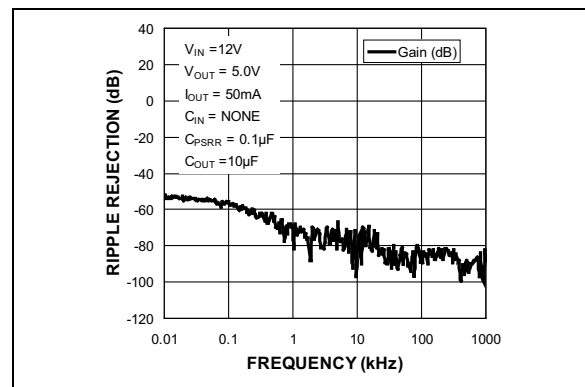

FIGURE 2-18: PSRR vs. Frequency.

* The temperature measurement was taken at the hottest point on the MAQ5282 case mounted on a 2.25 square inch PCB at an ambient temperature of +25°C; see the “Thermal Measurement” section. Actual results will depend upon the size of the PCB, ambient temperature, and proximity to other heat emitting components.

MAQ5282

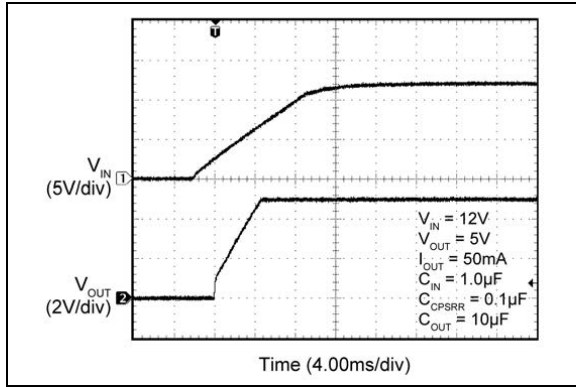

FIGURE 2-19: Soft Turn-On into Full Load.

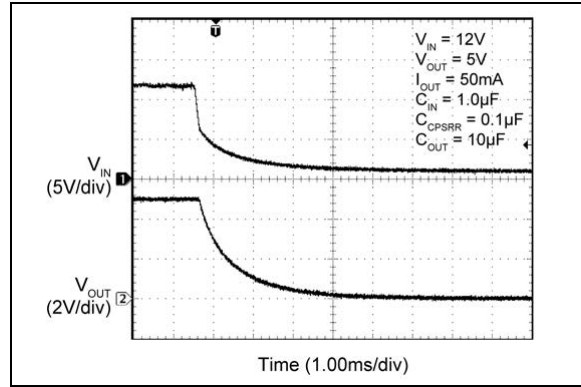

FIGURE 2-22: Hot Un-Plug.

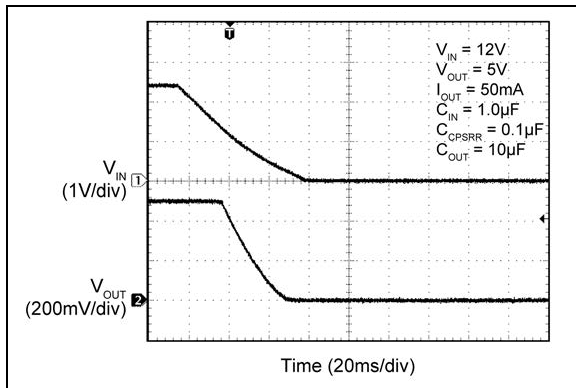

FIGURE 2-20: Soft Turn-Off.

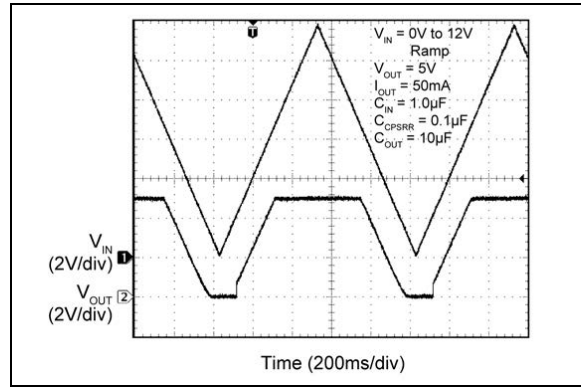

FIGURE 2-23: V_{IN} UVLO Threshold.

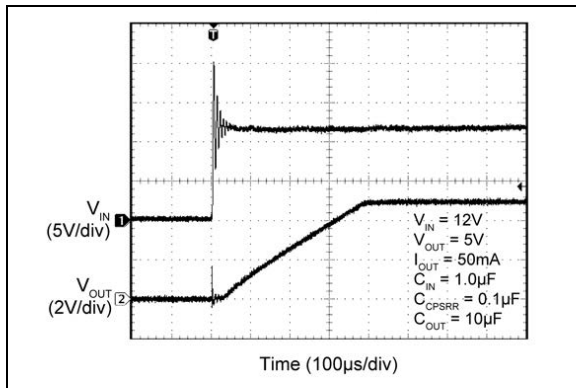

FIGURE 2-21: Hot Plug.

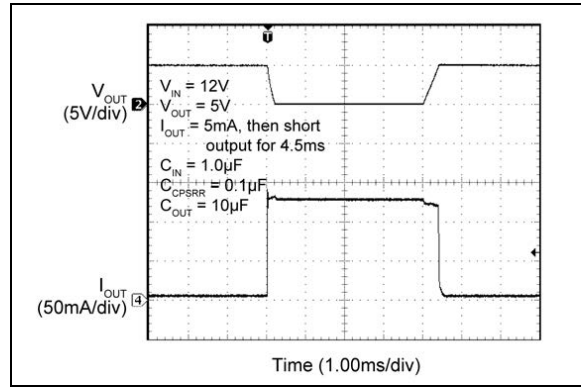

FIGURE 2-24: Current Limit.

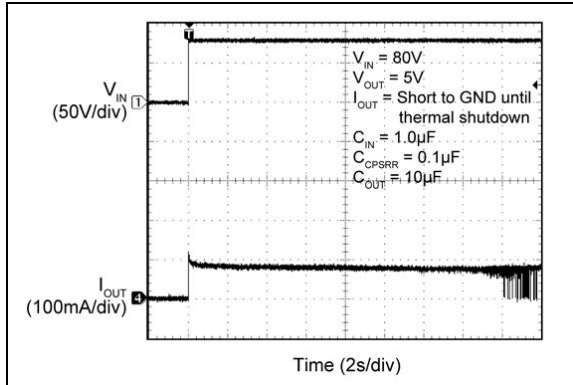

FIGURE 2-25: Thermal Shutdown Response.

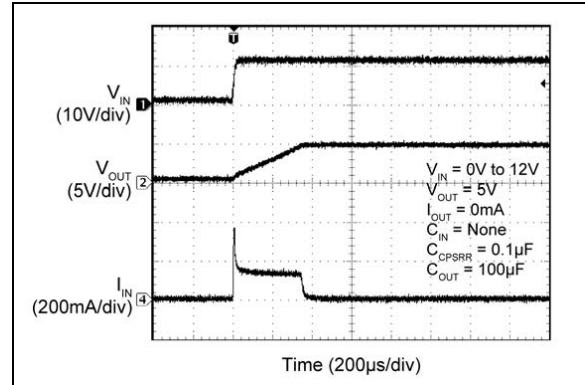

FIGURE 2-28: Inrush Current Response.

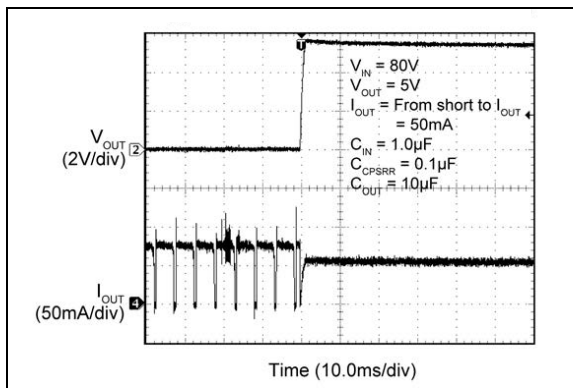

FIGURE 2-26: V_{OUT} Recovery from Thermal Shutdown.

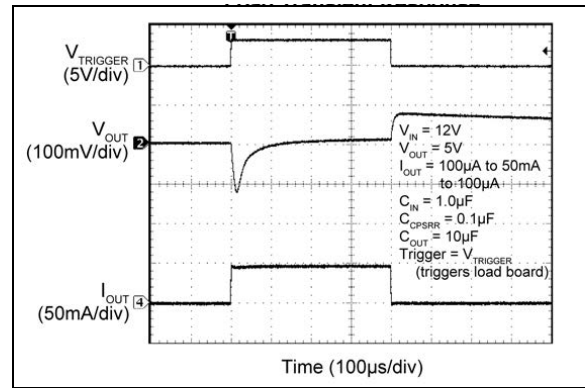

FIGURE 2-29: Load Transient Response.

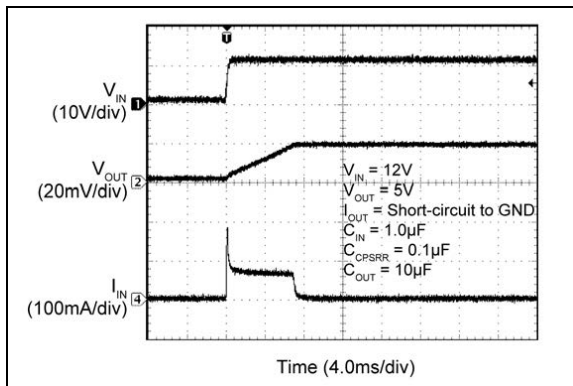

FIGURE 2-27: Turn-On into Short Circuit.

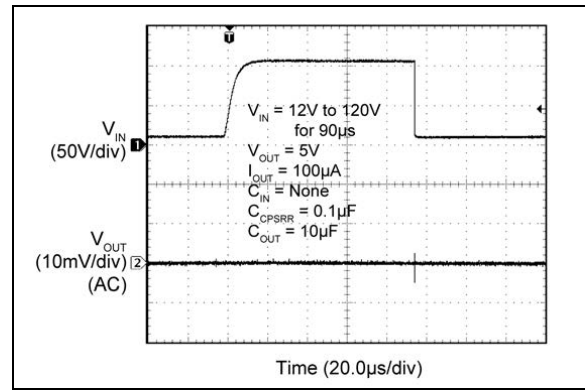

FIGURE 2-30: Line Transient Response.

MAQ5282

3.0 PIN DESCRIPTIONS

The descriptions of the pins are listed in [Table 3-1](#).

TABLE 3-1: PIN FUNCTION TABLE

Pin Number (Adj. Version)	Pin Number (Fixed Version)	Pin Name	Description
1	1	VIN	Supply Voltage Input. Connect 1 μ F capacitor from VIN to GND.
2, 3, 7	2, 3, 7	NC	Not internally connected. Connect NC to GND or leave unconnected.
4	4	CPSRR	Bypass Capacitor Connection. Connect 0.1 μ F capacitor from CPSRR to GND.
5	5	GND	Ground.
6	—	FB	Feedback Connection. For external resistor divider to set V_{OUT} .
—	6	SNS	Sense input. Connect SNS to VOUT.
8	8	VOUT	Regulator Output. Connect 10 μ F capacitor from VOUT to GND.
EP	EP	ePAD	Exposed Pad for Thermal Relief. Connect EP to GND.

4.0 DETAILED DESCRIPTION

The MAQ5282 voltage regulator accepts a 6V to 120V input and has an ultra-low 6 μ A typical quiescent current while offering an excellent line transient response and PSRR. These features make it ideal for harsh, noisy environments. All options of the device offer 50 mA of output current. The MAQ5282YMME offers an adjustable output voltage from 1.27V to 5.5V. The MAQ5282-3.3YMME offers fixed 3.3V outputs and the MAQ5282-5.0YMME offers fixed 5.0V outputs. The YMME packaged devices feature a heat slug to more effectively remove heat from the die.

5.0 APPLICATIONS INFORMATION

5.1 Thermal Protection

The MAQ5282 has an internal thermal shutdown circuit to protect it from excessive heating of the die. When the junction temperature exceeds approximately +155°C, the output is disabled and the device begins to cool down. The device turns back on when the junction temperature cools by 15°C. This will result in a cycled output during continuous thermal-overload conditions.

5.2 Current Limit

The MAQ5282 features output current-limit protection. The output sustains a continuous short circuit to GND without damage to the device, but thermal shutdown often results.

5.3 Input Capacitor

Connect a 1 μ F capacitor from VIN to GND. Microchip recommends the C5750X7R2E105M, 1 μ F, 250V capacitor made by TDK. When using a different capacitor, ensure that the voltage rating of the capacitor exceeds any potential transient.

5.4 CPSRR Capacitor

Connect a 0.1 μ F capacitor from CPSRR to GND to maintain high power supply rejection. The voltage rating of the capacitor must be at least 14V.

5.5 Output Capacitor

Connect a 10 μ F capacitor from VOUT to GND. Ensure that the voltage rating of the capacitor exceeds the designed output voltage of the MAQ5282.

5.6 Output Voltage Setting

For the MAQ5282YMME, V_{OUT} is programmed from 1.27V to 5.5V using:

EQUATION 5-1:

$$V_{OUT} = V_{REF} \times \left(\frac{R1}{R2} + 1 \right)$$

Where:

V_{REF} = 1.27V

R1 and R2 are shown in the Typical Application Circuits.

5.7 Thermal Measurements

It is always wise to measure an IC's case temperature to make sure that it is within operating limits, but it is easy to get erroneous results. The standard thermocouple that comes with many voltage meters uses a large wire gauge that behaves like a heat-sink, resulting in artificially low case temperature measurements. Use a thermocouple of 36-gauge wire or smaller, such as the Omega (5SC-TT-K-36-36), to minimize the heat-sinking effect. Also, apply thermal compound to maximize heat transfer between the IC and the thermocouple.

An infrared thermometer is a recommended alternative. The IR thermometer from Optris has a 1 mm spot size, ideal for monitoring small surface mount packages. Also, the optional stand makes it easy to keep the beam on the IC for long periods of time.

7.0 PCB EVALUATION BOARD LAYOUT

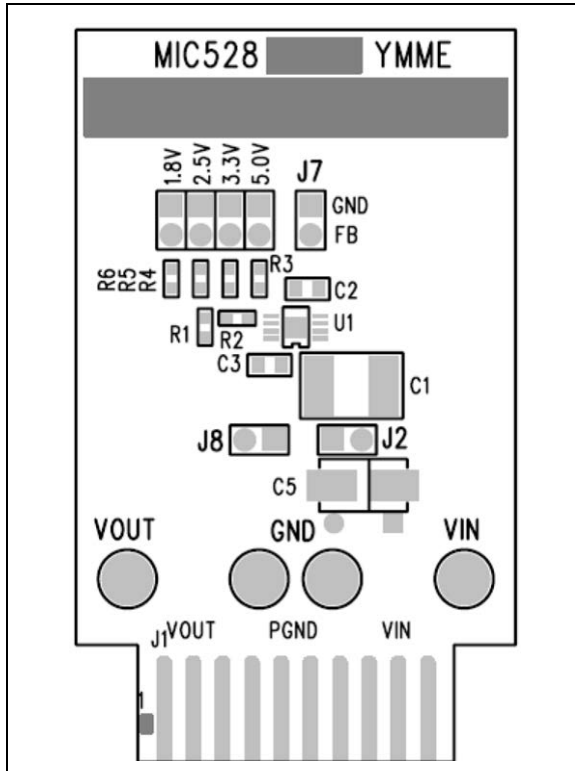

FIGURE 7-1: Top Layer Silk Screen.

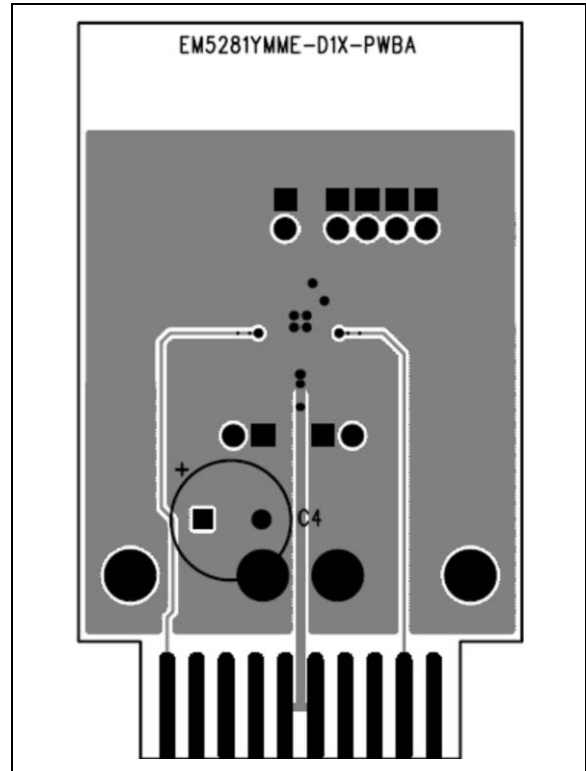

FIGURE 7-3: Bottom Layer Traces.

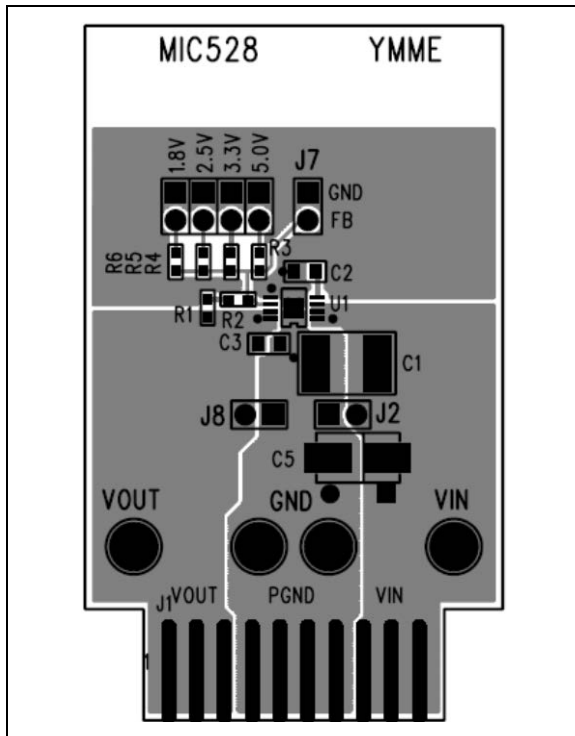

FIGURE 7-2: Top Layer Traces.

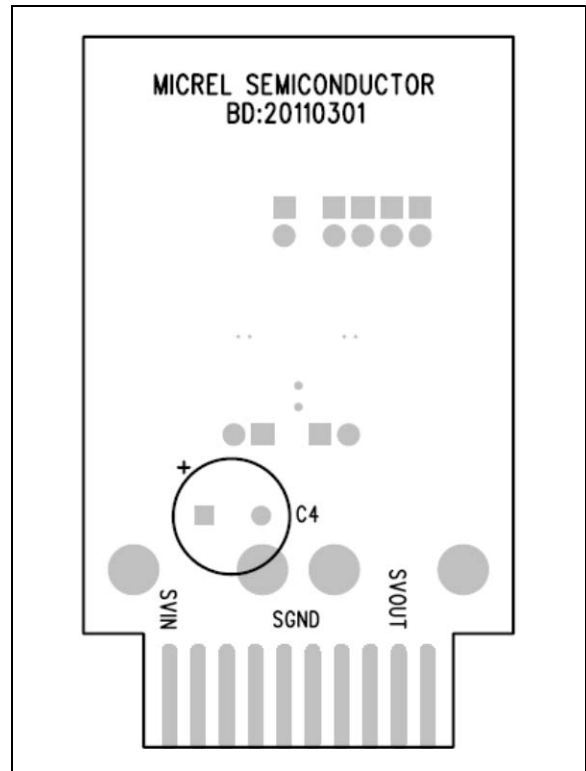

FIGURE 7-4: Bottom Layer Silk Screen.

MAQ5282

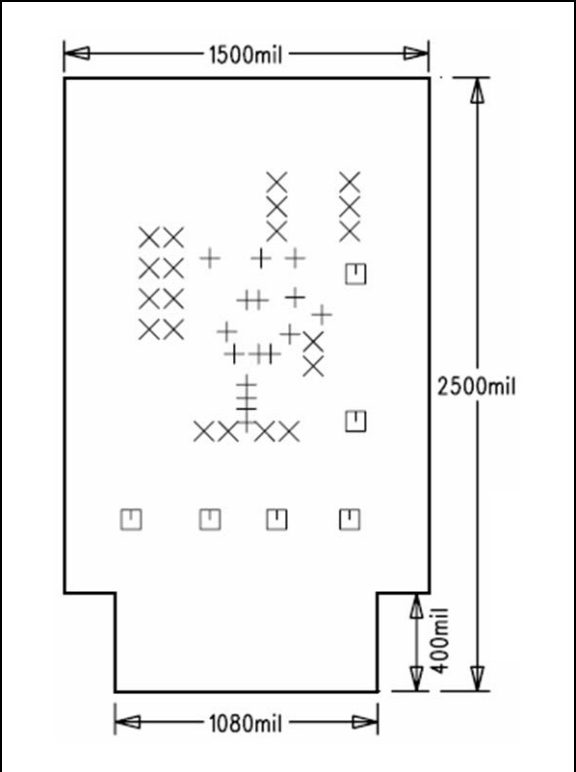
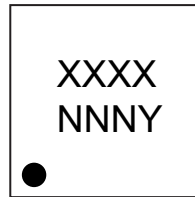

FIGURE 7-5: EV Board Dimensions.

8.0 PACKAGING INFORMATION

8.1 Package Marking Information

8-Lead MSOP*



Example

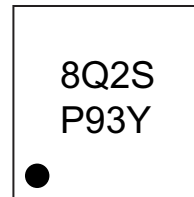

Legend:	XX...X	Product code or customer-specific information
	Y	Year code (last digit of calendar year)
	YY	Year code (last 2 digits of calendar year)
	WW	Week code (week of January 1 is week '01')
	NNN	Alphanumeric traceability code
	(e3)	Pb-free JEDEC® designator for Matte Tin (Sn)
	*	This package is Pb-free. The Pb-free JEDEC designator ((e3)) can be found on the outer packaging for this package.
	•, ▲, ▼	Pin one index is identified by a dot, delta up, or delta down (triangle mark).
Note:	In the event the full Microchip part number cannot be marked on one line, it will be carried over to the next line, thus limiting the number of available characters for customer-specific information. Package may or may not include the corporate logo.	
	Underbar (_) symbol may not be to scale.	

Note: If the full seven-character YYWWNNN code cannot fit on the package, the following truncated codes are used based on the available marking space:
 6 Characters = YWWNNN; 5 Characters = WWNNN; 4 Characters = WNNN; 3 Characters = NNN;
 2 Characters = NN; 1 Character = N

MAQ5282

8-Lead MSOP ePAD Package Outline and Recommended Land Pattern

TITLE

8 LEAD MSOP EPAD PACKAGE OUTLINE & RECOMMENDED LAND PATTERN

DRAWING #	MSOPEP-8LD-PL-1	UNIT	MM [INCH]
-----------	-----------------	------	-----------

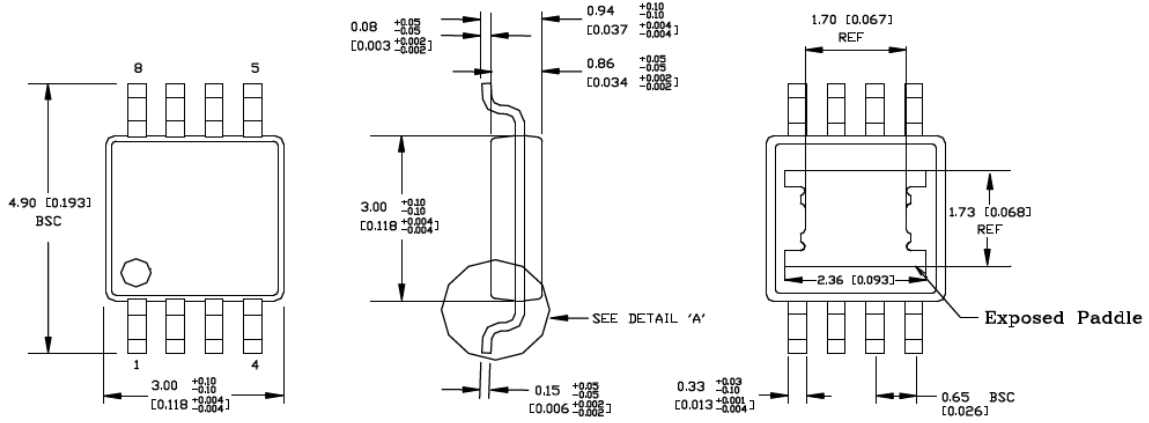

TOP VIEW

END VIEW

BOTTOM VIEW

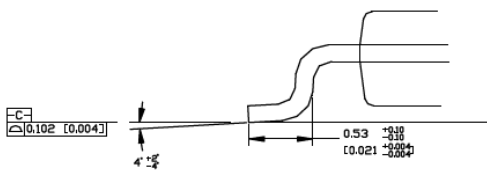

DETAIL A

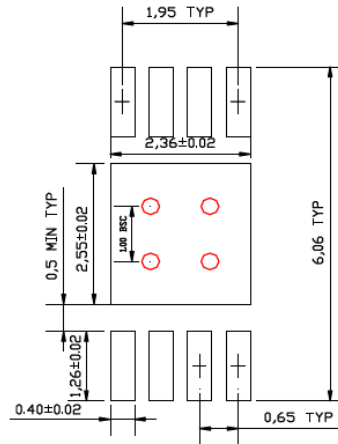

RECOMMENDED LAND PATTERN

NOTE:

- DIMENSION DOES NOT INCLUDE MOLD FLASH OR PROTRUSIONS, EITHER OF WHICH SHALL NOT EXCEED 0.20 [0.008] PER SIDE
- RED CIRCLES IN LAND PATTERN REPRESENT THERMAL VIAS, RECOMMENDED SIZE IS 0.30-0.35MM IN DIAMETER, 1.00 PITCH AND SHOULD BE CONNECTED TO GND FOR MAXIMUM PERFORMANCE

Note: For the most current package drawings, please see the Microchip Packaging Specification located at <http://www.microchip.com/packaging>.

APPENDIX A: REVISION HISTORY

Revision A (June 2022)

- Converted Micrel document MAQ5282 to Microchip data sheet DS20006690A.
- Minor text changes throughout.

MAQ5282

NOTES:

PRODUCT IDENTIFICATION SYSTEM

To order or obtain information, e.g., on pricing or delivery, contact your local Microchip representative or sales office.

<u>Part Number</u>	<u>-X.X</u>	<u>X</u>	<u>XX</u>	<u>-XX</u>	<u>VXX</u>
Device	Output Voltage	Temp. Range	Package	Media Type	Automotive Suffix
Device:	MAQ5282:	120V _{IN} , 50 mA, Ultra-Low I _Q , High-PSRR Linear Regulator			
Output Voltage:	<blank>=	Adjustable			
	3.3 =	3.3V			
	5.0 =	5.0V			
Temperature Range:	Y =	-40°C to +125°C			
Package:	MME=	8-Lead MSOP			
Media Type:	TR =	2,500/Reel			
	T5 =	500/Reel			
	<blank>=	100/Tube			
Automotive Suffix:	Vxx =	Automotive suffix in which "xx" is assigned by Microchip. VAO is standard automotive option.			

Examples:

a) MAQ5282YMME-VAO: MAQ5282, Adj. Output Voltage, -40°C to +125°C Temp. Range, 8-Lead MSOP, 100/Tube, Automotive Option

b) MAQ5282-3.3YMME-T5VAO: MAQ5282, 3.3V Output Voltage, -40°C to +125°C Temp. Range, 8-Lead MSOP, 500/Reel, Automotive Option

c) MAQ5282-5.0YMME-TRVAO: MAQ5282, 5.0V Output Voltage, -40°C to +125°C Temp. Range, 8-Lead MSOP, 2500/Reel, Automotive Option

Note 1: Tape and Reel identifier only appears in the catalog part number description. This identifier is used for ordering purposes and is not printed on the device package. Check with your Microchip Sales Office for package availability with the Tape and Reel option.

MAQ5282

NOTES:

Note the following details of the code protection feature on Microchip products:

- Microchip products meet the specifications contained in their particular Microchip Data Sheet.
- Microchip believes that its family of products is secure when used in the intended manner, within operating specifications, and under normal conditions.
- Microchip values and aggressively protects its intellectual property rights. Attempts to breach the code protection features of Microchip product is strictly prohibited and may violate the Digital Millennium Copyright Act.
- Neither Microchip nor any other semiconductor manufacturer can guarantee the security of its code. Code protection does not mean that we are guaranteeing the product is "unbreakable" Code protection is constantly evolving. Microchip is committed to continuously improving the code protection features of our products.

This publication and the information herein may be used only with Microchip products, including to design, test, and integrate Microchip products with your application. Use of this information in any other manner violates these terms. Information regarding device applications is provided only for your convenience and may be superseded by updates. It is your responsibility to ensure that your application meets with your specifications. Contact your local Microchip sales office for additional support or, obtain additional support at <https://www.microchip.com/en-us/support/design-help/client-support-services>.

THIS INFORMATION IS PROVIDED BY MICROCHIP "AS IS". MICROCHIP MAKES NO REPRESENTATIONS OR WARRANTIES OF ANY KIND WHETHER EXPRESS OR IMPLIED, WRITTEN OR ORAL, STATUTORY OR OTHERWISE, RELATED TO THE INFORMATION INCLUDING BUT NOT LIMITED TO ANY IMPLIED WARRANTIES OF NON-INFRINGEMENT, MERCHANTABILITY, AND FITNESS FOR A PARTICULAR PURPOSE, OR WARRANTIES RELATED TO ITS CONDITION, QUALITY, OR PERFORMANCE.

IN NO EVENT WILL MICROCHIP BE LIABLE FOR ANY INDIRECT, SPECIAL, PUNITIVE, INCIDENTAL, OR CONSEQUENTIAL LOSS, DAMAGE, COST, OR EXPENSE OF ANY KIND WHATSOEVER RELATED TO THE INFORMATION OR ITS USE, HOWEVER CAUSED, EVEN IF MICROCHIP HAS BEEN ADVISED OF THE POSSIBILITY OR THE DAMAGES ARE FORESEEABLE. TO THE FULLEST EXTENT ALLOWED BY LAW, MICROCHIP'S TOTAL LIABILITY ON ALL CLAIMS IN ANY WAY RELATED TO THE INFORMATION OR ITS USE WILL NOT EXCEED THE AMOUNT OF FEES, IF ANY, THAT YOU HAVE PAID DIRECTLY TO MICROCHIP FOR THE INFORMATION.

Use of Microchip devices in life support and/or safety applications is entirely at the buyer's risk, and the buyer agrees to defend, indemnify and hold harmless Microchip from any and all damages, claims, suits, or expenses resulting from such use. No licenses are conveyed, implicitly or otherwise, under any Microchip intellectual property rights unless otherwise stated.

For information regarding Microchip's Quality Management Systems, please visit www.microchip.com/quality.

Trademarks

The Microchip name and logo, the Microchip logo, Adaptec, AVR, AVR logo, AVR Freaks, BesTime, BitCloud, CryptoMemory, CryptoRF, dsPIC, flexPWR, HELDO, IGL00, JukeBlox, KeeLoq, Klear, LANCheck, LinkMD, maXStylus, maXTouch, MediaLB, megaAVR, Microsemi, Microsemi logo, MOST, MOST logo, MPLAB, OptoLyzer, PIC, picoPower, PICSTART, PIC32 logo, PolarFire, Prochip Designer, QTouch, SAM-BA, SenGenuity, SpyNIC, SST, SST Logo, SuperFlash, Symmetricom, SyncServer, Tachyon, TimeSource, tinyAVR, UNI/O, Vectron, and XMEGA are registered trademarks of Microchip Technology Incorporated in the U.S.A. and other countries.

AgileSwitch, APT, ClockWorks, The Embedded Control Solutions Company, EtherSynch, Flashtec, Hyper Speed Control, HyperLight Load, Libero, motorBench, mTouch, Powermite 3, Precision Edge, ProASIC, ProASIC Plus, ProASIC Plus logo, Quiet-Wire, SmartFusion, SyncWorld, Temux, TimeCesium, TimeHub, TimePictra, TimeProvider, TrueTime, and ZL are registered trademarks of Microchip Technology Incorporated in the U.S.A.

Adjacent Key Suppression, AKS, Analog-for-the-Digital Age, Any Capacitor, AnyIn, AnyOut, Augmented Switching, BlueSky, BodyCom, Clockstudio, CodeGuard, CryptoAuthentication, CryptoAutomotive, CryptoCompanion, CryptoController, dsPICDEM, dsPICDEM.net, Dynamic Average Matching, DAM, ECAN, Espresso T1S, EtherGREEN, GridTime, IdealBridge, In-Circuit Serial Programming, ICSP, INICnet, Intelligent Paralleling, IntelliMOS, Inter-Chip Connectivity, JitterBlocker, Knob-on-Display, KoD, maxCrypto, maxView, memBrain, Mindi, MiWi, MPASM, MPF, MPLAB Certified logo, MPLIB, MPLINK, MultiTRAK, NetDetach, Omniscient Code Generation, PICDEM, PICDEM.net, PICkit, PICtail, PowerSmart, PureSilicon, QMatrix, REAL ICE, Ripple Blocker, RTAX, RTG4, SAM-ICE, Serial Quad I/O, simpleMAP, SimpliPHY, SmartBuffer, SmartHLS, SMART-I.S., storClad, SQI, SuperSwitcher, SuperSwitcher II, Switchtec, SynchroPHY, Total Endurance, Trusted Time, TSHARC, USBCheck, VariSense, VectorBlox, VeriPHY, ViewSpan, WiperLock, XpressConnect, and ZENA are trademarks of Microchip Technology Incorporated in the U.S.A. and other countries.

SQTP is a service mark of Microchip Technology Incorporated in the U.S.A.

The Adaptec logo, Frequency on Demand, Silicon Storage Technology, and Symmcom are registered trademarks of Microchip Technology Inc. in other countries.

GestIC is a registered trademark of Microchip Technology Germany II GmbH & Co. KG, a subsidiary of Microchip Technology Inc., in other countries.

All other trademarks mentioned herein are property of their respective companies.

© 2022, Microchip Technology Incorporated and its subsidiaries.

All Rights Reserved.

ISBN: 978-1-6683-0591-1



MICROCHIP

Worldwide Sales and Service

AMERICAS

Corporate Office
2355 West Chandler Blvd.
Chandler, AZ 85224-6199
Tel: 480-792-7200
Fax: 480-792-7277
Technical Support:
<http://www.microchip.com/support>
Web Address:
www.microchip.com

Atlanta

Duluth, GA
Tel: 678-957-9614
Fax: 678-957-1455

Austin, TX

Tel: 512-257-3370

Boston

Westborough, MA
Tel: 774-760-0087
Fax: 774-760-0088

Chicago

Itasca, IL
Tel: 630-285-0071
Fax: 630-285-0075

Dallas

Addison, TX
Tel: 972-818-7423
Fax: 972-818-2924

Detroit

Novi, MI
Tel: 248-848-4000

Houston, TX

Tel: 281-894-5983

Indianapolis

Noblesville, IN
Tel: 317-773-8323
Fax: 317-773-5453
Tel: 317-536-2380

Los Angeles

Mission Viejo, CA
Tel: 949-462-9523
Fax: 949-462-9608
Tel: 951-273-7800

Raleigh, NC

Tel: 919-844-7510

New York, NY

Tel: 631-435-6000

San Jose, CA

Tel: 408-735-9110
Tel: 408-436-4270

Canada - Toronto

Tel: 905-695-1980
Fax: 905-695-2078

ASIA/PACIFIC

Australia - Sydney
Tel: 61-2-9868-6733

China - Beijing
Tel: 86-10-8569-7000

China - Chengdu
Tel: 86-28-8665-5511

China - Chongqing
Tel: 86-23-8980-9588

China - Dongguan
Tel: 86-769-8702-9880

China - Guangzhou
Tel: 86-20-8755-8029

China - Hangzhou
Tel: 86-571-8792-8115

China - Hong Kong SAR
Tel: 852-2943-5100

China - Nanjing
Tel: 86-25-8473-2460

China - Qingdao
Tel: 86-532-8502-7355

China - Shanghai
Tel: 86-21-3326-8000

China - Shenyang
Tel: 86-24-2334-2829

China - Shenzhen
Tel: 86-755-8864-2200

China - Suzhou
Tel: 86-186-6233-1526

China - Wuhan
Tel: 86-27-5980-5300

China - Xian
Tel: 86-29-8833-7252

China - Xiamen
Tel: 86-592-2388138

China - Zhuhai
Tel: 86-756-3210040

ASIA/PACIFIC

India - Bangalore
Tel: 91-80-3090-4444

India - New Delhi
Tel: 91-11-4160-8631

India - Pune
Tel: 91-20-4121-0141

Japan - Osaka
Tel: 81-6-6152-7160

Japan - Tokyo
Tel: 81-3-6880-3770

Korea - Daegu
Tel: 82-53-744-4301

Korea - Seoul
Tel: 82-2-554-7200

Malaysia - Kuala Lumpur
Tel: 60-3-7651-7906

Malaysia - Penang
Tel: 60-4-227-8870

Philippines - Manila
Tel: 63-2-634-9065

Singapore
Tel: 65-6334-8870

Taiwan - Hsin Chu
Tel: 886-3-577-8366

Taiwan - Kaohsiung
Tel: 886-7-213-7830

Taiwan - Taipei
Tel: 886-2-2508-8600

Thailand - Bangkok
Tel: 66-2-694-1351

Vietnam - Ho Chi Minh
Tel: 84-28-5448-2100

EUROPE

Austria - Wels
Tel: 43-7242-2244-39
Fax: 43-7242-2244-393

Denmark - Copenhagen
Tel: 45-4485-5910
Fax: 45-4485-2829

Finland - Espoo
Tel: 358-9-4520-820

France - Paris
Tel: 33-1-69-53-63-20
Fax: 33-1-69-30-90-79

Germany - Garching
Tel: 49-8931-9700

Germany - Haan
Tel: 49-2129-3766400

Germany - Heilbronn
Tel: 49-7131-72400

Germany - Karlsruhe
Tel: 49-721-625370

Germany - Munich
Tel: 49-89-627-144-0
Fax: 49-89-627-144-44

Germany - Rosenheim
Tel: 49-8031-354-560

Israel - Ra'anana
Tel: 972-9-744-7705

Italy - Milan
Tel: 39-0331-742611
Fax: 39-0331-466781

Italy - Padova
Tel: 39-049-7625286

Netherlands - Drunen
Tel: 31-416-690399
Fax: 31-416-690340

Norway - Trondheim
Tel: 47-7288-4388

Poland - Warsaw
Tel: 48-22-3325737

Romania - Bucharest
Tel: 40-21-407-87-50

Spain - Madrid
Tel: 34-91-708-08-90
Fax: 34-91-708-08-91

Sweden - Gothenberg
Tel: 46-31-704-60-40

Sweden - Stockholm
Tel: 46-8-5090-4654

UK - Wokingham
Tel: 44-118-921-5800
Fax: 44-118-921-5820